

CEMETERY COMMISSION MONTHLY MEETING  
DONN B. GRIFFIN ROOM, TOWN HALL  
732 MAIN STREET  
TUESDAY OCTOBER 4, 2022 AT 9:00AM

\*Public may attend the meeting in person, access the meeting on Channel 18 (Broadcasting Live), or can login to the meeting remotely using the following login information\*  
Tue, Oct 4, 2022 9:00 AM - 10:30 AM (EDT)

**Please join my meeting from your computer, tablet or smartphone.**

<https://meet.goto.com/312191517>

**You can also dial in using your phone.**

United States: [+1 \(872\) 240-3412](tel:+18722403412)

- I. CALL TO ORDER
- II. APPROVAL OF MINUTES FROM.
- III. CORRESPONDENCE FROM TOWN HALL & ASSOCIATIONS
  - A. AmeriCorps Cape Cod Year 24 Swearing-In Ceremony scheduled for 9/28 at 10.AM
  - B. OTHER BUSINESS.
- IV. OLD BUSINESS
  - A. Up to date totals for Revolving Account and Cemetery Budget.
  - B. Bank Street Cemetery.
  - C. Update on fence repairs.
  - D. Update of Veterans Memorial Circle.
  - E. Update on CPC Articles.
  - F. OTHER OLD BUSINESS.
- V. NEW BUSINESS
  - A. Bills: Eversource, WB Mason Office Supplies, Seaside Arborists Tree Removal.
  - B. DEEDS: Rev. Judith M Stevens Thomas & Robert Thomas for 207 Pond Grove (2 Cremations) in Island Pond for \$550.00, Thomas P. O'Neill II for 115R Main Avenue (6 Graves) in Mount Pleasant for \$4,800.00, Mark & Deborah Bernabei for 58R Pine Avenue in Mount Pleasant for \$800.00, Thomas & Jennifer Luby for 84 Nickerson Avenue (A, B & C) in Evergreen for \$2,700.00, Margaret O'Leary for 57B,C,D, 58A & 88D Nickerson Avenue for \$4,000.00 and Alan Hoskins for 45C, D, 46 A, B, C, D, E, 58B, C, D, 59A, B C Nickerson Avenue for \$10,400.00
  - C. OTHER BUSINESS.
- VI. DATE AND TIME OF NEXT MEETING
- VII. ADJOURNMENT

AUTHORIZED POSTING OFFICER:

POSTED BY: \_\_\_\_\_  
TOWN CLERK

DATE: \_\_\_\_\_

## Robbin Kelley

---

**From:** Katherine Garofoli <katherine.garofoli@barnstablecounty.org>  
**Sent:** Monday, September 19, 2022 4:55 PM  
**To:** Katherine Garofoli  
**Cc:** Michael Andranovich; Phoebe Plank; Mike Maguire  
**Subject:** Update about ACC's Individual Placement structure

Dear Individual Placement Partners,

I want to extend my sincerest thanks to all of you for your understanding, kind words, and willingness to adapt to the proposed program changes that we are facing this year. It was a priority for me and the staff to include our partners in this process, and I was amazed by the participation.

After reviewing all the responses from the survey, the program staff has been able to identify an effective configuration of the 11 members in the most beneficial way to our partners. There will be minimal cuts to placements. All assigned placements will be **one day per week**. This structure allows us to host additional smaller group service projects that will benefit many community partners.

You will receive communication from either Phoebe or Mike regarding your placement award and day assigned shortly. If a one-day assignment is no longer feasible for your organization, please contact me to discuss foregoing this placement.

Please save the date for the **Year 24 Swearing-In Ceremony scheduled for 9/28 at 10 AM** on the front steps of the Superior Court House. After the ceremony, I would like to invite you to an early luncheon up in the Harborview Room that provides a great chance to meet the members. There will be a variety of food available for all dietary types. At 1 PM, there will be a speed networking session for the members to learn about our service partners' professions and then we will jump right into the required IP training from 1:30 PM to 3 PM.

Please note that all events will be in-person. Program staff will monitor reports of COVID-19 transmission rates and determine if changes need to be made to ensure the safety of members, staff, and service partners.

I look forward to our partnerships thriving in Year 24!

Sincerely,



**Kat Garofoli**

**Program Manager | AmeriCorps Cape Cod**

**Barnstable County, Regional Government of Cape Cod**

Email [katherine.garofoli@barnstablecounty.org](mailto:katherine.garofoli@barnstablecounty.org) | Office (774) 314-2182

3195 Main Street | P.O. Box 427 | Barnstable, MA 02630

[www.americorpscapedod.org](http://www.americorpscapedod.org)

# CEMETERY REVOLVING FY2023

Date	16111004		16111002		PC	Balance
	Revenue	Admin	Mark out	Lot Returns		
						\$82,130.50
	Previous Balance from FY2021					
7/8/2022		\$100.00				100.00
	Admin Wildman EV					
	Admin Sheppard EV	\$100.00				100.00
	Admin Wyatt	\$100.00				100.00
7/14/2022	Lot Sale Brown IP	\$450.00			50.00	500.00
	Admin Chinault IP		\$100.00			100.00
	Mark out Wyatt IP			\$75.00		75.00
	Mark out Walker IP			\$75.00		75.00
	Mark out Weddle IP			\$75.00		75.00
	Mark out Fitzpatrick IP			\$75.00		75.00
	Mark out Sauvage IP			\$75.00		75.00
	Admin Smith NH		\$100.00			100.00
	Mark out Bounce EV			\$75.00		75.00
	Admin Kingsbury MP		\$100.00			100.00
	Admin Brown IP		\$100.00			100.00
7/21/2022	Lot Sale Sprout IP	\$720.00			80.00	800.00
	Lot Sale Powers IP	\$4,320.00			480.00	4,800.00
7/27/2022	Admin Marcotte IP		\$100.00			100.00
7/29/2022	Admin Duffy IP		\$100.00			100.00
	Admin Gilfort IP		\$100.00			100.00
8/3/2022	Lot Sale Oneill MP	\$4,320.00			480.00	4,800.00
	Mark out Perry IP			\$75.00		75.00
	Admin Dawson PG		\$100.00			100.00
	Admin McGrath MP		\$100.00			100.00
	Mark out Goodrick IP			\$75.00		75.00
	Admin & Mark out Brumfield EV		\$100.00			175.00
	Admin Harriman E MP		\$100.00			100.00
	Admin Harriman S MP		\$100.00			100.00
	Mark out Harriman MP			\$75.00		75.00
8/5/2022	Agway Garden IP					-351.26
8/11/2022	Admin Small EV		\$100.00			100.00
8/13/2022	Admin Vafiades V MP		\$100.00			100.00
	Admin Vafiades G MP		\$100.00			100.00
8/26/2022	Admin McAllister EV		\$100.00			100.00
8/19/2022	Admin Doane IP		\$100.00			100.00
						351.26

## Robbin Kelley

---

**From:** Ralph ... All Cape Fence <acfralph@comcast.net>  
**Sent:** Tuesday, October 4, 2022 8:11 AM  
**To:** Robbin Kelley  
**Cc:** allcapefence@comcast.net  
**Subject:** RE: quote

Robbin,  
We we get to it this month.

Thank-you  
Ralph

On 10/04/2022 7:59 AM Robbin Kelley <rkelley@town.harwich.ma.us> wrote:

Ralph

Thank you.

Can you also let me know when you will be able to fix the fence at Mount Pleasant.

Robbin

---

**From:** Ralph ... All Cape Fence [mailto:acfralph@comcast.net]  
**Sent:** Tuesday, October 4, 2022 7:58 AM  
**To:** Robbin Kelley <rkelley@town.harwich.ma.us>  
**Cc:** allcapefence@comcast.net  
**Subject:** quote

Robin,

Attached is your updated quote.

Please call 508-394-3024 for any questions.

Thank-you

**ALL Cape Fence Inc**

508-394-2422

Mailing Address:

Email: [allcapefence@comcast.net](mailto:allcapefence@comcast.net) P.O. Box 318 S. Dennis, Ma. 02660

362 Upper County Rd, S. Dennis Ma.

[www.allcapefence.com](http://www.allcapefence.com)

Name BANK STREET CEMETERY Date 10/4/22  
 Address BANK ST  
 State HARWICH Zip \_\_\_\_\_  
 Promised Date 430-7549  
 Description \_\_\_\_\_ QTY PRICE AMOUNT

Install 39 sections of  
Pressure treated split  
RAIL FENCE

\$4,680.00

Material	
%	
Material total	
Tax	
Delivery Charge	
Labor	
Total	<u>4680 00</u>
Deposit	<u>XXXX XX</u>
Balance	<u>4680 00</u>

rkelly@town.harwich.ma.us

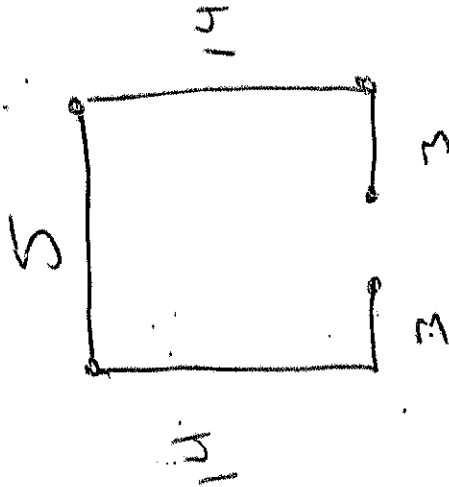

- The Revolutionary War (1775-1783)
- War of 1812 (1812-1815)
- Mexican-American War (1846-1848)
- American Civil War (1861-1865)
- Spanish-American War (1898)
- World War I (1914-1918)
- World War II (1939-1945)
- Korean War (1950-1953)

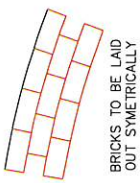
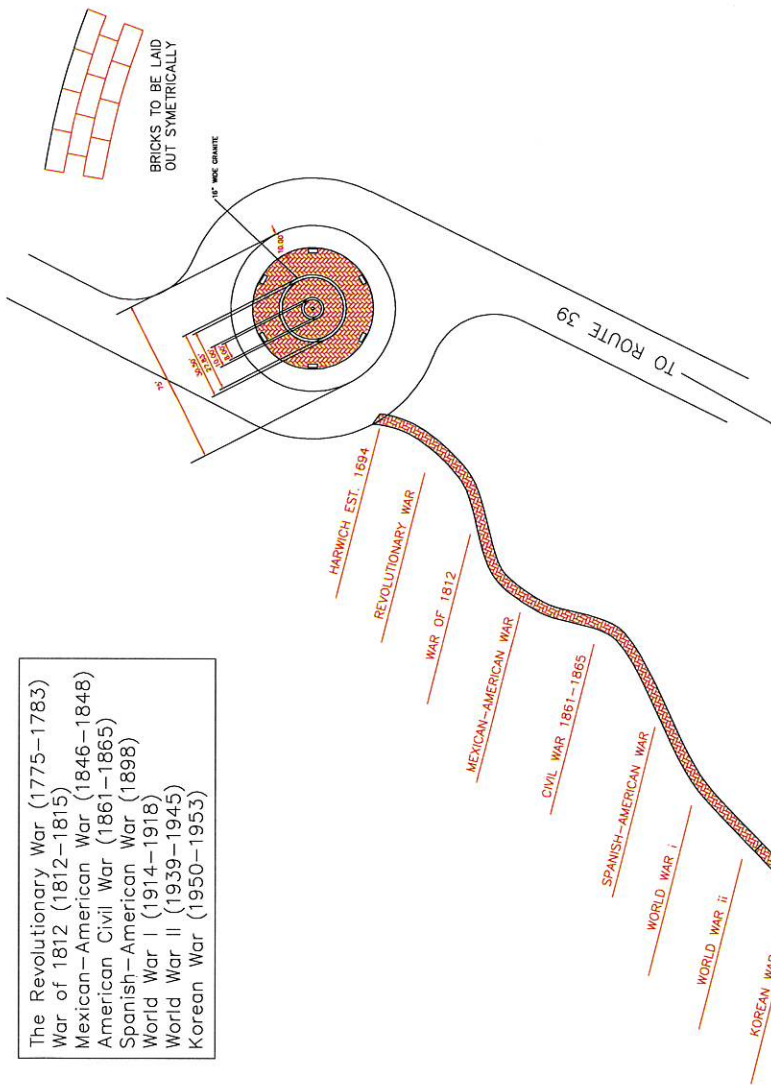

BRICKS TO BE LAID  
OUT SYMMETRICALLY

14" WIDE GRANITE

"EVERGREEN CEMETERY"

WALK OF REMEMBRANCE  
SKETCH PLAN  
(FOR ILLUSTRATION ONLY)  
AS PREPARED FOR  
HARWICH CEMETERY COMMISSION

JULY 21, 1961  
SCALE 1" = 40'

PAUL E. SWENDE  
PROFESSIONAL LAND SURVEYOR  
P.O. BOX 114  
DUNSTON, MA  
02529

NOTE: THIS PLAN IS NOT BASED ON AN INSTRUMENT SURVEY AND IS FOR ILLUSTRATION PURPOSES ONLY. ACTUAL WALKWAY LOCATION SUBJECT TO INSTRUMENT SURVEY.

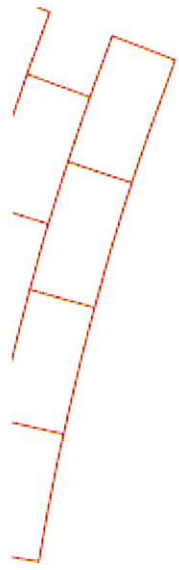

BRICKS TO BE LAID  
OUT SYMETRICALLY

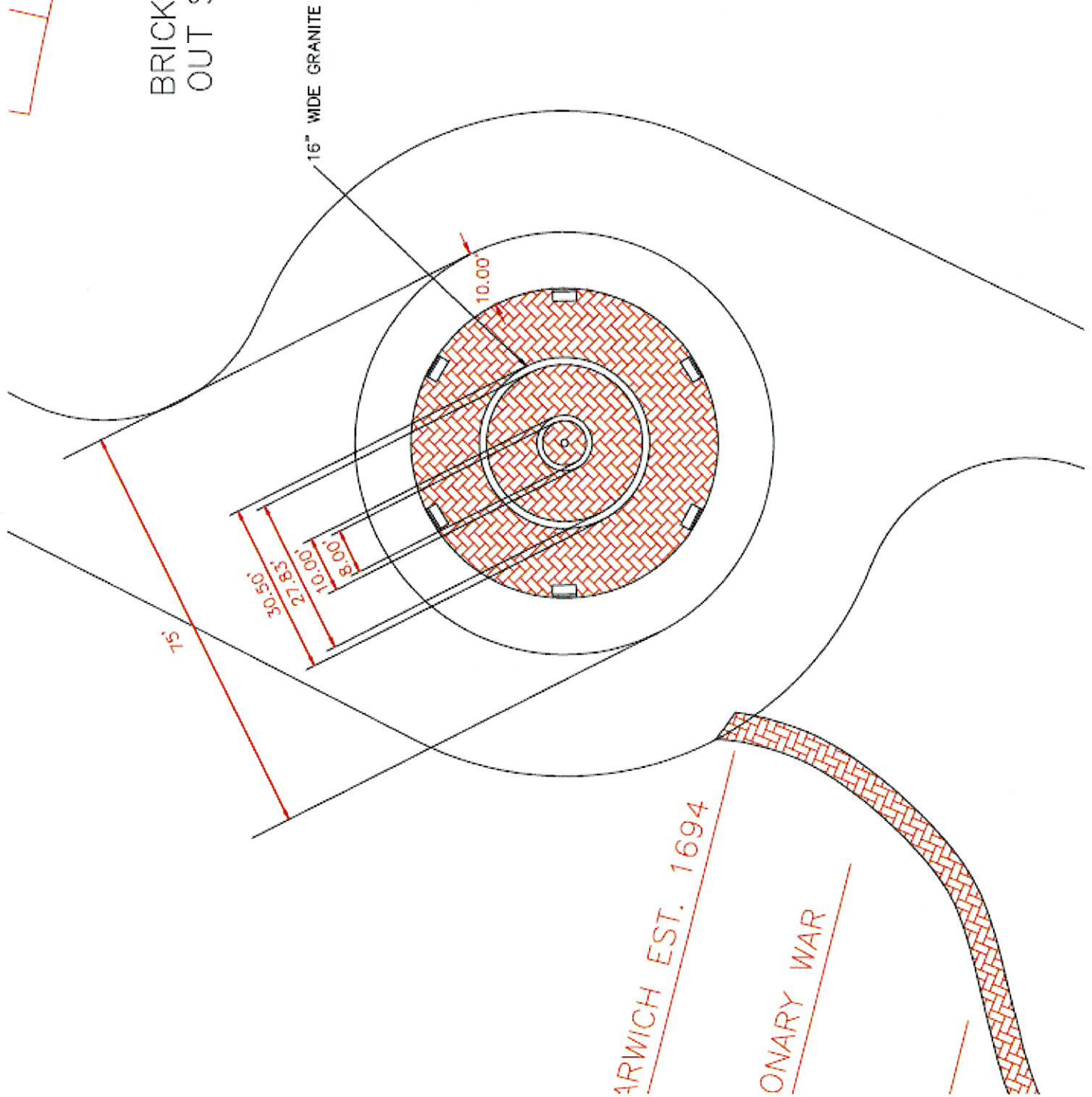

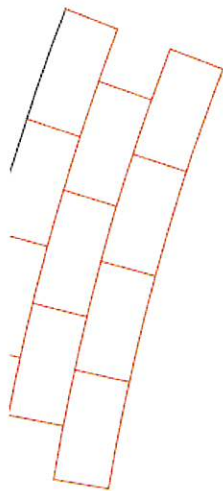

BRICKS TO BE LAID  
OUT SYMETRICALLY

16" WIDE GRANITE

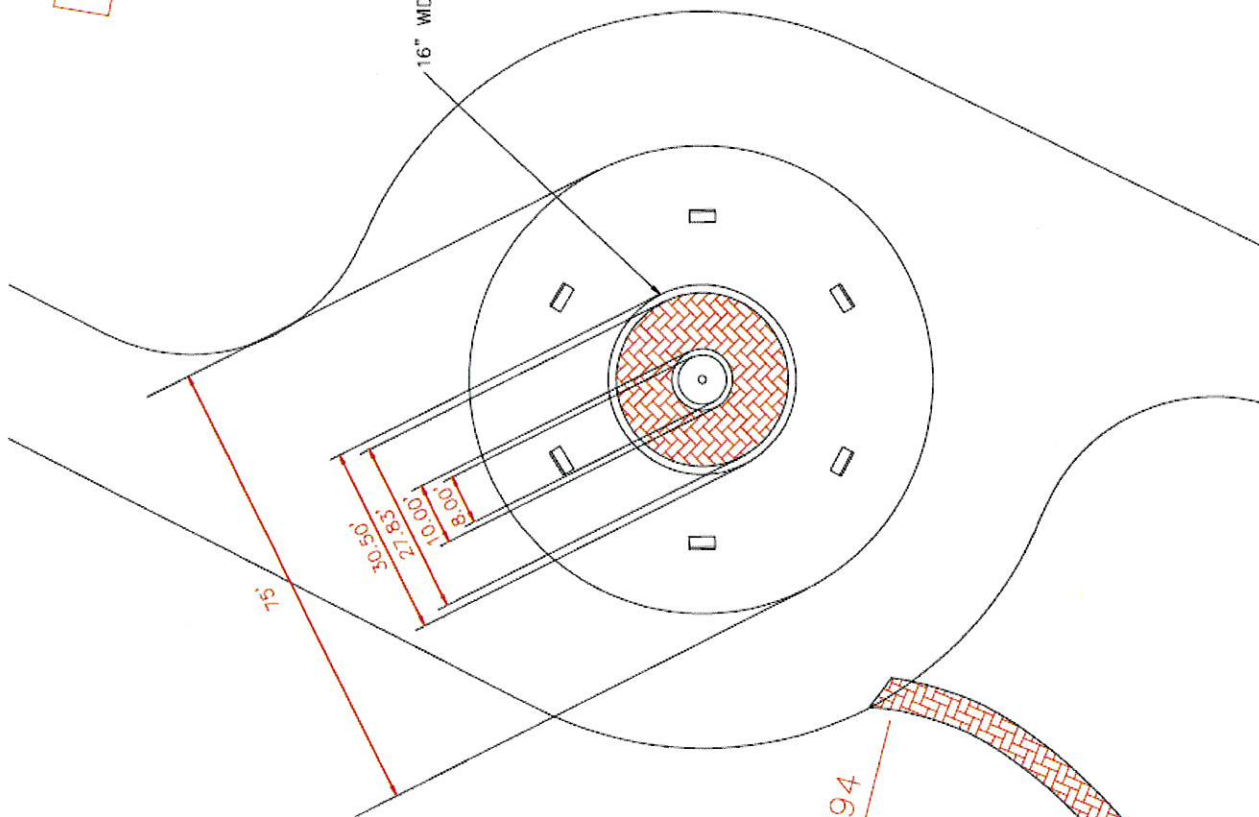

15'

30.50'

27.83'

10.00'

8.00'

HARWICH EST. 1694

REVOLUTIONARY WAR

WAR OF 1812

N WAR





## **HARWICH CEMETERY COMMISSION**

**Office**-100 Oak Street, Harwich 02645

**Mail** -732 Main Street, Harwich, 02645

rkelly@town.harwich.ma.us



September 30, 2022

Community Preservation Committee:  
Updates on Open Articles:

### **HISTORIC:**

Article #32 TM 2020 – Pine Grove Cemetery Gravestone Conservation. Appropriated Amount: \$75,000.00.

Was awarded to Village Green Restoration, Inc. from East Falmouth July 8, 2021.

**Has been completed** \$42,900 report and invoice sent to CPC and Jan email's.

**Money to be returned to the CPC is \$32,100.00**

### **RECREATION:**

Article #29 TM 2021 - Phase I of II for Veterans Memorial Circle at Evergreen Cemetery. Appropriated Amount: \$48,385.00.

Install flags, lighting and related electrical service,

**Contracts have been awarded to the following**

Farrell Electric \$36,525.00 installation of Electrical Service to Lighting at Circle.

**Completed 9/30/2022**

Hamco Flagpoles & Flags \$15,489.00 Flag Poles and Flags

Total of 52,014.00 (\$48,385.00 CPC & \$8,629.00 Cemetery Revolving Account)

### **HISTORIC:**

Article #31 TM 2022 - East Harwich Union Cemetery Gravestone Conservation.

\$118,800.00. Procurement Checklist has been approved and has gone out to BID, the BID opening is August 10, 2022 at Town Hall.

**Contract has been awarded to**

Village Green Restoration, Inc. from East Falmouth for \$61,890.00

### **Submitted CPC Articles:**

**HISTORIC:** Phase II Veterans Memorials at Evergreen Cemetery. Revolutionary War and Civil War Memorials. Will be finalizing the names to be place and requesting price quotes on cost for memorials.

North Harwich Cemetery Fence and Rails.

Robbin Kelley  
Cemetery Administrator:

Application # \_\_\_\_\_  
*For Administrative Use*

**TOWN OF HARWICH - COMMUNITY PRESERVATION COMMITTEE**  
**2022 CPA PROJECT FUNDING REQUEST APPLICATION**  
**FISCAL YEAR 2023-2024**

Submission Date: October 3, 2022

**APPLICANT INFORMATION**

**Applicant:** Cemetery Department

Town Committee, Board or Organization: Cemetery Commission

Legal Mailing Address: 732 Main Street, Harwich, MA 02645

Phone: 508-430-7549 Email Address: rkelley@town.harwich.ma.us

**Project Manager:** Robbin Kelley

Legal Mailing Address: 10 Glen Road, Harwich, MA 02645

Phone: 508-430-7549 Email Address: rkelley@town.harwich.ma.us

**Second Contact Person:** Steven Conner

Legal Mailing Address: 21 Black Loch Drive, Harwich, MA 02645

Phone: 508-237-7978 Email Address: sconner80@gmail.com

**PROJECT INFORMATION**

PROJECT TITLE: Revolutionary & Civil War Memorials

PROJECT AMOUNT REQUESTED: \$256,282.40 (232,984 x 10% contingency 23,298.40)

PROJECT DESCRIPTION: To design, build, deliver and install granite memorials

The Revolutionary War and Civil War Memorials will be placed at Evergreen Cemetery in the walk of Remembrance.

ESTIMATED START DATE: July 2023

ESTIMATED COMPLETION DATE: July 2024

**Three years from the release of funds (July 2023) funds may be rescinded automatically; waivers may be sought.**

**CPA CATEGORY**

**APPLICANTS PLEASE TAKE NOTE \*\*please check boxes for all that apply\*\***

- Open Space:** This application is for the “acquisition, preservation, rehabilitation and/or preservation of open space”.
- Historic:** This application is for the “acquisition, preservation, rehabilitation and/or restoration of historic resources”. Please provide the date on which the HDHC reviewed and endorsed this application.
- Community Housing:** This application is for the “acquisition, creation, preservation and/or support of community housing”.
- Recreation:** This application is for the “acquisition, creation, preservation, rehabilitation and/or restoration of land for recreational use”.

**How does this project fit into Harwich’s Local Comprehensive Plan and/or other Plan?**

This project is part of the Cemetery Commission’s Master Plan, which includes planning, Assessments and Inventories of all the cemetery properties. Evergreen Cemetery had been selected as location for the Veterans Memorial Circle and Walk of Remembrance. It is critical to both the history of our great nation and more specifically the history of the Town of Harwich that we acknowledge and preserve the sacrifices made by our veterans and their families.

**How does this project benefit the citizens of Harwich? If appropriate, has the application sought public opinion or input? If not, why?**

The Harwich Veteran’s Memorial will allow future generations to connect with our heroic past to honor the men and women of Harwich who served our great country. When completed, the Walk of Remembrance and Veterans Memorial Circle will provide an enduring historical reminder, from the past to the present, for generations to come.

**Please list other Commissions/Boards/Committees/Organizations that may have involvement, jurisdiction, partnering:**

<u>Commissions/Boards/Committees/Organizations</u>	Please have them initial here after their review
Harwich Cemetery Commission Sept 26, 2022	
Harwich Historical Commission October Meeting	

**Describe their response, or provide written comments/input:**

Positive comments from Shawnee Carroll, Veterans Service Officer for the Town.

**Please list any documentation to be forthcoming and reason for delay.**

All documents are included. Will update with Historic Commission decision.

**PROJECT BUDGET:** Attach a dated and detailed line item project budget estimate for your funding request. If the request involves a Town-owned asset, provide the project's projected operating expenses, including maintenance.

**COST ESTIMATE(S):** \$ \$232,984 Quotes plus 10% contingency 23,298.40= \$256,282.40  
Attach cost estimates or firm quotes (if available) for all projects.

**LAND and/or BUILDING ACQUISITION PROJECTS:** The following **must** also be submitted, as applicable:

- Surveys and/or plot plans for the property
- Appraisals and agreements (if not available then submit by December 1, 2022)
- Name of present owner and attach copy of deed conveying property unto present owner.
- Property address, Harwich Assessor's property identification (Map#, Parcel #).
- For proposed Open Space land purchases, be prepared to discuss public access with the Committee.

\*\*\*\*\*

By signing below, the Applicant represents and warrants that all the information included is true and correct to the best of the signer's knowledge and belief. Further, the Applicant acknowledges in the event that the Community Preservation Committee agrees to grant funds to Applicant (and subject to Town Meeting approval), this application together with any Terms and Conditions shall constitute a binding agreement, between the Applicant and the Community Preservation Committee. Further, Applicant acknowledges and agrees to execute any additional grant agreements should the Community Preservation Committee so request.

**ATTESTATION: I HEREBY ATTEST THAT THE INFORMATION CONTAINED IN THIS APPLICATION IS TRUE AND ACCURATE TO THE BEST OF MY KNOWLEDGE.**

Signature - ~~Chief Executive Officer~~ or Board Chair

Title

*Robbin Kelley* *Cemetery Admin.*

Printed Name Robbin Kelley

Date 3 Oct 2022

**APPLICATIONS MUST BE RECEIVED BY OCTOBER 3, 2022 NO LATER THAN 4 PM**

Revised: May 16, 2022

**Cape Cod Memorials**  
 PO Box 1141  
 Orleans, MA 02653  
 (508)255-8600  
 brian@capecodmemorials.net



## Estimate

**ADDRESS**

Robbin Kelley  
 Town Of Harwich  
 100 Oak St  
 Harwich, MA 02645  
 United States

**ESTIMATE # 2244**  
**DATE 09/22/2022**

DATE	DESCRIPTION	QTY	RATE	AMOUNT
09/22/2022	Barre grey granite monument, 6-0 x 0-10 x 7-6, unpolished, oval top	1	25,350.00	25,350.00
09/22/2022	Barre grey granite base, 7-0 x 1-6 x 0-10, unpolished top,	1	3,510.00	3,510.00
09/22/2022	Engraving services -Approx 2,100 characters	1	19,386.00	19,386.00
09/22/2022	Foundation, installation and shipping	1	10,000.00	10,000.00
			<b>SUBTOTAL</b>	58,246.00
			<b>TAX</b>	0.00
			<b>TOTAL</b>	<b>\$58,246.00</b>

Accepted By

Accepted Date

# CIVIL WAR MEMORIAL

JEREMIAH A. HEYLINGBURG JEREMIAH A. HEYLINGBURG JEREMIAH A. HEYLINGBURG  
JEREMIAH A. HEYLINGBURG JEREMIAH A. HEYLINGBURG JEREMIAH A. HEYLINGBURG

JEREMIAH A. HEYLINGBURG JEREMIAH A. HEYLINGBURG JEREMIAH A. HEYLINGBURG  
JEREMIAH A. HEYLINGBURG JEREMIAH A. HEYLINGBURG JEREMIAH A. HEYLINGBURG

**Cape Cod Memorials**

PO Box 1141  
Orleans, MA 02653  
(508)255-8600  
brian@capecodmemorials.net



# Estimate

**ADDRESS**

Robbin Kelley  
Town Of Harwich  
100 Oak St  
Harwich, MA 02645  
United States

**ESTIMATE #** 2254  
**DATE** 09/29/2022

---

DATE	DESCRIPTION	QTY	RATE	AMOUNT
09/22/2022	Barre grey granite monument, 6-0 x 0-10 x 7-6, unpolished, oval top	3	25,350.00	76,050.00
09/22/2022	Barre grey granite base, 7-0 x 1-6 x 0-10, unpolished top,	3	3,510.00	10,530.00
09/22/2022	Engraving services -Approx 6,500 characters	3	19,386.00	58,158.00
09/22/2022	Foundation, installation and shipping	3	10,000.00	30,000.00
			SUBTOTAL	174,738.00
			TAX	0.00
			<b>TOTAL</b>	<b>\$174,738.00</b>

Accepted By

Accepted Date

# REVOLUTIONARY WAR MEMORIAL

EBENEZER A. ELDREDGE  
EBENEZER A. ELDREDGE

EBENEZER A. ELDREDGE  
EBENEZER A. ELDREDGE

EBENEZER A. ELDREDGE  
EBENEZER A. ELDREDGE

EBENEZER A. ELDREDGE  
EBENEZER A. ELDREDGE

EBENEZER A. ELDREDGE  
EBENEZER A. ELDREDGE

EBENEZER A. ELDREDGE  
EBENEZER A. ELDREDGE



# Department of Veterans' Services

*Barnstable, Bourne, Brewster, Chatham, Dennis, Eastham, Harwich, Mashpee,  
Orleans, Provincetown, Sandwich, Truro, Wareham, Wellfleet, and Yarmouth District*

66 Falmouth Road, Hyannis, MA 02601  
TEL. (508) 778-8740 - FAX (508) 778-8745  
WEBSITE: Capevets.org

GREGORY J. QUILTY  
Director and Service Officer

SHAWNEY L. CARROLL  
Assistant Director & Service Officer

Kevin Voegeli  
Service Officer

Guy Gottschalk  
Service Officer

October 3, 2022

RE: Letter of Support

To Whom It May concern:

This is a letter of support for the Harwich Cemetery Director, Robin Kelley. I fully support her continued efforts in representing the town of Harwich veterans who have served this country valiantly with a Revolutionary War Memorial/Civil War Memorial. Her dedication and perseverance in vetting veterans who went into the service from the town of Harwich is very commendable. As a Veteran Service Officer for Barnstable County and the Town of Harwich, I absolutely support this project.



Shawney Carroll, USAFR (Ret)  
Assistant Director, Veteran Services  
Barnstable District

## Civil War Memorial for the Town of Harwich

### **EIGHTH REGIMENT MASSACHUSETTS VOLUNTEER INFANTRY**

Chase, Alonzo F. — Priv. — Res. Harwich; mariner; 20; enl. July 18, 1864; must. July 18, 1864; must, out Nov. 10, 1864.

Chase, Peter B. — Priv. — Res. Harwich; mariner; 30; enl. July 18, 1864; must. July 18, 1864; must, out Nov. 10, 1864.

### **TWENTIETH REGIMENT MASS. VOLUNTEER INFANTRY**

Bumpus, Martin A. — Priv. — Res. Harwich; 18; nailer; enl. Aug. 11, 1862; must. Aug. 18, 1862; disch. for disability, March 3, 1863

Robbins, George H. — Priv. — Res. Harwich; 28; nail maker; enl. and must. Aug. 18, 1862 disch. for disability, Oct. 7, 1862.

### **TWENTY-FOURTH REGIMENT MASS. VOLUNTEER INFANTRY**

Wartrous, George W. — Priv. — Res. Harwich; 22; seaman; enl. Oct. 8, 1861; must. Oct. 9, 1861; re-enlist. Jany. 2, 1864; must, out Jany. 20, 1866.

Chase, Joseph C. — Priv. — Res. West Harwich; 22; gardener; enl. Oct. 28, 1861; must. Nov. 8, 1861; re-enlist. Jany. 4, 1864; wounded May 16, 1864, Drury's Bluff, Va.; must, out Jany. 20. 1866.

### **THIRTY-FIRST REGIMENT MASS. VOLUNTEER INFANTRY**

Nickerson, Ira — Priv. — Res. Harwich; 44; fisherman; enl. Feb. 7, 1862; must. Feb. 14, 1862 disch. for disability, June 16. 1862.

### **THIRTY-FIFTH REGIMENT MASS. VOLUNTEER INFANTRY**

George N. Munsell — Asst. Surgeon — Res. Harwich; 26; surgeon; comm. July 31, 1862; must. Aug. 21, 1862; resigned and disch. to date April 24, 1863.

Heylingburg, Jeremiah — Priv. — Res. Harwich; 27; mechanic; enl. July 30, 1862; must. Aug. 9, 1862; must, out June 9, 1865.

Hook, Gilman — Priv. — Res. Harwich; 36; mechanic; enl. July 30, 1862; must. Aug. 9, 1862 disch. for disability, Feb. 6, 1863, Frederick City, Md.

### **THIRTY-NINTH REGIMENT MASS. VOLUNTEER INFANTRY**

Field, William — Priv. — Res. Harwich; 48; mechanic; enl. July 26, 1862; must. Aug. 18, 1862; must, out June 2, 1865.

Jones, Asa L. — Priv. — Res. Harwich; 22; mariner; enl. July 26, 1862; must. Aug. 18, 1862; prom. Corpl., Dec. 1, 1862; Sergt., March 17, 1863; disch. Sept. 15, 1863, for promotion. See Officer U. S. Col. Troops.

Small, Thomas E. — Priv. — Res. Harwich; 18; mariner; enl. July 26, 1862; must. Aug. 18, 1862; must, out June 2, 1865.

Smalley, Henry — Priv. — Res. Harwich; 20; mariner; enl. July 26, 1862; must. Aug. 18, 1862; prom. Corpl., Sept. 30, 1863; must, out June 2, 1865.

**FORTIETH REGIMENT MASS. VOLUNTEER INFANTRY**

Company A

Cash, Abraham S. — Priv. — Res. Harwich; 21; seaman; enl. Aug. 13, 1862; must. Aug. 23, 1862; disch. June 9, 1865, from genl. hospl., York, Penna.

Gifford, Jonathan — Priv. — Res. Harwich; 30; farmer; enl. Aug. 5, 1862; must. Aug. 23, 1862; taken prisoner, March 1, 1864, at Cedar Run, Fla.; died Aug. 1, 1864, of disease, at Andersonville, Ga., a Prisoner of War.

Butler, Charles — Priv. — Res. Harwich; 24; seaman; enl. Aug. 11, 1862; must. Aug. 22, 1862; disch. March 12, 1863, for disability, at Fairfax Seminary Hospl., Alexandria, Va.

Chase, Danforth H. — Priv. — Res. Harwich; 21; seaman; enl. Aug. 11, 1862; must. Aug. 22, 1862; transf. to V. R. C, Aug. 6, 1864; must, out Aug. 22, 1865, as of 19th Co. 2d Battln. V. R. C, at Providence, R. I.

Dunn, James — Priv. — Res. Harwich; 21; seaman; enl. Aug. 11, 1862; must. Aug. 22, 1862; wounded June 1, 1864, at Cold Harbor, Va.; transf. Jany. 1, 1865, to V. R. C.; disch. June 30, 1865, as of 76th Co. 2d Battln. V. R. C.

**FORTY-THIRD REGIAIENT MASS. VOLUNTEER INFANTRY**

Charles G. Rodman — Corpl. — Res. Harwich; seaman; 44; enl. Sept. 2, 1862; must. Sept. 20, 1862; must, out July 30, 1863.

Luther Crowell — Corpl. — Res. Harwich; landsman; 38; enl. Sept. 2, 1862; must. Sept. 20, 1862; must, out July 30, 1863.

Baker, Winslow — Priv. — Res. Harwich; peddler; 22; enl. Sept. 2, 1862; must. Sept. 20, 1862 must, out July 30, 1863. See Co. "H" 58th Mass. Inf.

Bassett, William H. H. — Priv. — Res. Harwich; laborer; 21; enl. Sept. 2, 1862; must. Sept. 20 1862; must, out July 30, 1863. See Co. "A" 58th Mass. Inf.

Cahoon, Thomas Y. — Priv. — Res. Harwich; seaman; 18; enl. Sept. 2, 1862 ; must. Sept. 20 1862; must, out July 30, 1863. See Co. "A" 58th Mass. Inf.

Clark, David P. — Priv. — Res. Harwich; seaman; 21; enl. Sept. 2, 1862; must. Sept. 20, 1862 must, out July 30, 1863.

Crabbe, Joseph — Priv. — Res. Harwich; seaman; 44; enl. Sept. 2, 1862; must. Sept. 20, 1862 must, out July 30, 1863.

Dow, John N, — Priv. — Res. Harwich; mason; 38; enl. Sept. 2, 1862; must. Sept. 20, 1862 must, out July 30, 1863.

Ellis, Alvarado C. — Priv. — Res. Harwich; seaman; 25; enl. Sept. 14, 1862; must. Sept. 20 1862; must, out July 30, 1863.

## Civil War Memorial for the Town of Harwich

Freeman, Charles S. — Priv. — Res. Harwich; farmer; 19; enl. Aug. 22, 1862; must. Sept. 20, 1862; must, out July 30, 1863.

Freeman, Gideon H. — Priv. — Res. Harwich; carpenter; 21; enl. Aug. 22, 1862; must. Sept. 20, 1862; must, out July 30, 1863.

McVea, David M. — Priv. — Res. Harwich; seaman; 27; enl. Aug. 25, 1862; must. Sept. 20, 1862; must, out July 30, 1863. See Co. "L" 2d Mass. Hy. Arty.

Parker, Thomas H. K. — Priv. — Res. Harwich; merchant; 45; enl. Sept. 4, 1862; must. Sept. 20, 1862; must, out July 30, 1863.

Small, Joshua — Priv. — Res. Harwich; wheelwright; 42; enl. Sept. 20, 1862; must. Sept. 20, 1862; disch. Feb. 16, 1863, for disability, at Newbern, N. C.

### **FIFTY-EIGHTH REGIMENT MASS. VOLUNTEER INFANTRY**

Allen, Albert F — Priv. — Res. Harwich; enl. Jan 14, 1864; must. Jun 24, 1865; Imprisonment Jul 30, 1864 Petersburg, Va, Last known res. Chicago Ill.

Baker, Scotto B. N. — Priv. — Res. Harwich; 20; Seaman; enl. Jany. 5, 1864; must. Feb 8, 1864; rank change 1<sup>st</sup> Lieut. May 3, 1865; 2<sup>nd</sup> Lieut. Aug 8, 1865; must, out Jul 14, 1865.

Bassett, Benjamin — Priv. — Res. Harwich; 21; mariner; enl. Jany 5, 1864; must. Jany. 14, 1864; must, out July 4, 1865.

Bassett, William H. H. — Priv. — Res. Harwich; 22; seaman; enl. Jany. 4, 1864; must. Jany. 14, 1864; prisoner July 30, 1864, Petersburg, Va.; died of disease, Jany. 10, 1865, at Danville, Va., a Prisoner of War. See Co. "E" 43d Mass. Inf. (9 mos.).

Burgess, George G. — Priv. — Res. Harwich; 18; sailor; enl. Dec. 15, 1863; must. Jany. 14, 1864; must, out July 26, 1865.

Cahoon, Simeon — Priv. — Res. Harwich; 22; mariner; enl. Dec. 26, 1863; must. Jany. 14, 1864; wounded May 6, 1864, Wilderness, Va.; died of wounds, July 25, 1864, Washington, D. C.

Chase, Heman, Jr. — Priv. — Res. Harwich; 36; seaman; enl. Dec. 18, 1863; must. Jany. 14, 1864; prisoner July 30, 1864, Petersburg, Va., as Sergt.; paroled, date not shown; comm. 2d Lieut., Aug. 8, 1864; must. Jany. 24, 1865; comm. 1st Lieut., to date Nov. 1, 1864; must. April 17, 1865; prisoner April 2, 1865, Petersburg, Va.; released April 11, 1865; must, out July 14, 1865, as 1st Lieut, of Co. "G". Brevet Captain U. S. Vols., to date April 2, 1865. See U. S. Navy, as Herman Chase.

Doane, Francis L. — Priv. — Res. Harwich; 33; mariner; enl. Jany. 5, 1864; must. Jany. 14, 1864; prisoner May 26, 1864, North Anna River, Va.; paroled Nov. 20, 1864, Savannah, Ga. no further record.

Doane, Solomon N. — Priv. — Res. Harwich; 22; mariner; enl. Jany. 5, 1864; must. Jany. 14, 1864; wounded May 6, 1864, Wilderness, Va.; prisoner May 26, 1864, North Anna River, Va.; died of disease, Aug. 24, 1864, Andersonville, Ga., a Prisoner of War,

Eldredge, Alpheus — Priv. — Res. Harwich; 33; mariner; enl. Jany. 5, 1864; must. Jany. 14, 1864; wounded June 6, 1864, Cold Harbor, Va.; died of wounds, June 15, 1864, Washington, D. C.

## Civil War Memorial for the Town of Harwich

Ellis, Cyrus, 2d — Priv. — Res. Harwich; 18; mariner; enl. Dec. 16, 1863; must. Jany. 14, 1864 prisoner July 30, 1864, Petersburg, Va.; exchanged March 27, 1865; must, out June 21, 1865.

Hamilton, Charles W. — Priv. — Res. Harwich; 31; sailor; enl. Dec. 5, 1863; must. Jany. 14, 1864; wounded May 12, 1864, Spottsylvania, Va.; missing in action, April 2, 1865, Petersburg, Va.; disch. June 15, 1865, a Corpl.

Handy, Moses A. — Priv. — Res. Harwich; 43; sailor; enl. Dec. 17, 1863; must. Jany. 14, 1864 prisoner May 26, 1864, North Anna River, Va.; died of disease, Oct. 1, 1864, Andersonville, Ga., a Prisoner of War.

Jordan, Jahiel — Priv. — Res. Harwich; 37; shoemaker; enl. Dec. 31, 1863; must. Jany. 14, 1864; prisoner July 30, 1864, Petersburg, Va.; paroled Oct. 18, 1864; must, out June 23, 1865.

Kendrick, David — Priv. — Res. Harwich; 26; mariner; enl. Jany. 1, 1864; must. Jany. 14, 1864; wounded June 3, 1864, Cold Harbor, Va., as Sergt. ; comm. 2d Lieut, from 1st Sergt., May 3, 1865; not must. ; must, out July 14, 1865, as 1st Sergt.

Kendrick, Isaac L. — Priv. — Res. Harwich; 33; seaman; enl. Jany. 21, 1864; must. Feb. 8, 1864; must, out June 7, 1865, as Corpl.

Lenihan, Daniel — Priv. — Res. Harwich; 21; weaver; enl. Dec. 26, 1863; must. Jany. 14, 1864; must, out May 25, 1865. Also had service in Co. "A" 5th R. I. Hy. Arty.

Nickerson, Charles W. — Priv. — Res. Harwich; 20; mariner; enl. Dec. 11, 1863; must. Jany. 14, 1864; prisoner July 30, 1864, Petersburg, Va.; exchanged Feb. 22, 1865; must, out June 28, 1865.

Nickerson, George W. — Priv. — Res. Harwich; 19; mariner; enl. Dec. 15, 1863; must. Jany. 14, 1864; disch. to date Oct. 12, 1864. See U. S. Navy.

Phillips, Warren, Jr. — Priv. — Res. Harwich; 20; mariner; enl. Jany. 5, 1864; must. Jany. 14, 1864; disch. for disability, Nov. 17, 1864, near Poplar Grove Church, Va.

Ryder, David P. — Priv. — Res. Harwich; 27; sailor; enl. Dec. 12, 1863; must. Jany. 14, 1864; wounded May 12, 1864, Spottsylvania, Va.; must, out July 14, 1865, as Corpl.

Ryder, Ezra B. — Priv. — Res. Harwich; 25; mariner; enl. Dec. 11, 1863; must. Jany. 14, 1864; prisoner Aug. 16, 1864, Petersburg, Va.; escaped Nov., 1864; must, out July 14, 1865.

Silver, Antonio — Priv. — Res. Harwich; 42; mariner; enl. Dec. 11, 1863; must. Jany. 14, 1864; wounded May 6, 1864, Wilderness, Va.; disch. for disability, July 20, 1865.

Simons, Asa — Priv. — Res. Harwich; 42; sailor; enl. Dec. 25, 1863; must. Jany. 14, 1864; disch. for disability, June 20, 1865, Alexandria, Va.

Smalley, Ebenezer — Priv. — Res. Harwich; 25; carpenter; enl. Jany. 5, 1864; must. Jany. 14, 1864; wounded June 3, 1864, Cold Harbor, Va.; and June 17, 1864, Petersburg, Va.; died of wounds, July 11, 1864, at Harwich, Mass.

Smith, Stephen — Priv. — Res. Harwich; 42; mariner; enl. Jany. 5, 1864; must. Jany. 14, 1864 wounded and missing. May 6, 1864, Wilderness, Va.; no further record.

## Civil War Memorial for the Town of Harwich

Studley, George S. — Priv. — Res. Harwich; 25; sailor; enl. Dec. 16, 1863; must. Jany. 14, 1864; wounded May 18, 1864, Spottsylvania, Va.; must, out July 14, 1865.

Tuttle, Charles — Priv. — Res. Harwich; 36; carpenter; enl. Jany. 5, 1864; must. Jany. 14, 1864; must, out July 14, 1865.

Tuttle, John B. — Priv. — Res. Harwich; 39; cooper; enl. Dec. 31, 1863; must. Jany. 14, 1864 wounded May 6, 1864, Wilderness, Va.; and June 3, 1864, Cold Harbor, Va.; disch. for wounds, May 26, 1865, Philadelphia, Penna.

### Company C

Doane, Everett W. — Priv. — Res. Harwich; 18; mariner; enl. Jany. 23, 1864; must. Feb. 20, 1864; killed April 2, 1865, Petersburg, Va.

Doane, Moses — Priv. — Res. Harwich; 19; mariner; enl. Jany. 23, 1864; must. Feb. 20, 1864; wounded May 12, 1864, Spottsylvania, Va.; disch. for wounds, Aug. 21, 1865, at Worcester, Mass.

### Company G

Chase, Horace B. — Priv. — Res. Harwich; 27; mariner; enl. Jany. 30, 1864; must. March 26, 1864; wounded May 12, 1864, Spottsylvania, Va.; must, out July 14, 1865, as Corpl.

### Company H

Baker, Winslow — Priv. — Res. Harwich; 23; painter; enl. Jany. 5, 1864; must. April 18, 1864; prisoner Sept. 30, 1864, Poplar Grove Church, Va.; died of disease, Dec. 31, 1864, Salisbury N. C, a Prisoner of War. See Co. "E" 43d Mass. Inf. (9mos.).

Barstow, Joseph — Priv. — Res. Harwich; 31; cooper; enl. Feb. 23, 1864; must. April 18, 1864; disch. for disability, Nov. 12, 1864, Portsmouth Grove Hospl., R. I.

Chase, Edward C. — Priv. — Res. Harwich; 24; seaman; enl. Feb. 20, 1864; must. April 18, 1864; wounded June 3, 1864, Cold Harbor, Va.; and July 30, 1864, Petersburg, Va.; disch. for wounds, March 31, 1865.

Chase, Isaiah, 2d — Priv. — Res. Harwich; 31; seaman; enl. Feb. 23, 1864; must. April 18, 1864; died of disease, June 14, 1864, Alexandria, Va.

Chase, Thomas B. — Priv. — Res. Harwich; 22; seaman; enl. Feb. 20, 1864; must. April 18, 1864; prisoner July 30, 1864, Petersburg, Va.; died Feb. 9, 1865, Danville, Va., a Prisoner of War.

Crabbe, Alvah B. — Priv. — Res. Harwich; 18; seaman; enl. Feb. 20, 1864; must. April 18, 1864 wounded June 6, 1864, Cold Harbor, Va.; died of wounds, June 19, 1864, Washington, D. C

Doane, James B. — Priv. — Res. Harwich; 38; seaman; enl. Feb. 25, 1864; must. April 18, 1864; wounded May 12, 1864, Spottsylvania, Va.; transf. to V. R. C, March, 1865; must, out Sept. 8, 1865, as of Co. "K" 14th V. R. C.

Downey, Nathan — Priv. — Res. Harwich; 23; painter; enl. Feb. 25, 1864; must. April 18, 1864; prisoner July 30, 1864, Petersburg, Va., as Sergt. ; comm. 2d Lieut., May 3, 1865; must, out July 14, 1865, as Sergt.

## Civil War Memorial for the Town of Harwich

Drown, Alvan L. — Priv. — Res. Harwich; 38; farmer; enl. Jany. 27, 1864; must. April 18, 1864 died of disease, Sept. 1, 1864, Harwich, Mass. See Co. "E" 43d Mass. Inf. (9 mos.).

Hall, Freeman — Priv. — Res. Harwich; 27; seaman; enl. Feb. 23, 1864; must. April 18, 1864; wounded May 12, 1864, Spottsylvania, Va.; supposed to have died.

Small, Jonathan — Priv. — Res. Harwich; 37; farmer; enl. March 15, 1864; must. April 18, 1864; disch. May 23, 1865, Boston, Mass.

Wixon, Seth B. — Priv. — Res. Harwich; 24; seaman; enl. March 2, 1864; must. April 18, 1864 wounded July 30, 1864, Petersburg, Va.; must, out July 14, 1865, as Corpl.

### Company I

Loveland, Joseph — Priv. — Res. Harwich; 44; mariner; enl. Feb 27, 1864; must. May 13, 1864, must out July 14, 1865 in Washington, DC.

## **SECOND REGIMENT MASS. VOL. HEAVY ARTILLERY**

### Company I

Morang, William F. — Priv. — Res. Harwich; 20; farmer; enl. and must. Sept. 17, 1864; must out June 26, 1865.

## **FIRST BATTALION MASS. VOLUNTEER HEAVY ARTILLERY**

### Company B

Stone, James O. — Priv. — Res. Harwich; 22; mariner; enl. Oct. 4, 1862; must. Nov. 4, 1862; prom. Corpl., Sept. 8, 1863; Sergt., April 28, 1865; must, out June 29, 1865.

## **FOURTH REGIMENT MASS. VOLUNTEER CAVALRY**

### Company A

Frost, Joseph — Priv. — Res. Harwich; 23; mariner; enl. Dec. 9, 1863; must. Dec. 26, 1863 apptd. Corpl, Jany. 12, 1864; Sergt., Jany. 16, 1864; disch. May 4, 1865. See U. S. Navy, as Joseph B. Frost.

## **MASS. MEN IN ORGANIZATIONS FROM OTHER STATES**

Nickerson, John W. — 99th N. Y. Inf. — Res. Harwich, Mass.; 42; seaman; enl. and must. Nov. 1, 1861, for 3 yrs., as Priv. Co. "B"; disch. for disability, Sept. 25, 1863, at Fort Monroe, Va.

## **MASS. SOLDIERS IN U. S. ARMY AND U. S. VOLUNTEERS**

Miles, Newell W. — Band, 11th U. S. Inf. — Res. Lowell, Mass.; credit Harwich, Mass.; 19; soldier; enl. Dec. 21, 1864, Fort Independence, Boston Harbor, Mass., for 3 yrs.; died Jany. 4, 1866, Richmond, Va. Had prior service in Co. "G " 11th U. S. Inf.

## **ENLISTMENTS IN MISCELLANEOUS UNITS ENGINEER CORPS**

## Civil War Memorial for the Town of Harwich

Baker, James M. — Artif., Co. "C" — Res. Harwich; 23; carpenter; enl. Nov. 7, 1861, at Boston, for 3 yrs.; disch. Nov. 7, 1864, at Camp Woodbury, Va., as of Co. "D".

### MASSACHUSETTS ENLISTMENTS IN VETERAN RESERVE CORPS

Armington, Josiah — Priv., V. R. C. — Res. —; credit Harwich, Mass.; 39; carpenter; enl. and must. Dec. 22, 1864, Boston, for 3 yrs.; must, out Nov. 16, 1865, as Private, Co. "F" 9th V. R. C. See Co. "H" 20th Mass. Inf.

Hanwell, Robert — Priv., Co. "H" 13th V. R. O. — Res. London, Eng.; credit Harwich, Mass.; 43; boot fitter; enl. and must. Sept. 16, 1864, Boston, for 3 yrs.; reported to have been mustered out Nov. 13, 1865, as Private, Co. "H" 13th V. R. C. See Co. "K" 3d Mass. Cavalry.

Harris, William — Priv., V. R. C. — Res. Boston, Mass.; credit Harwich, Mass.; 43; laborer; enl. and must. Dec. 23, 1864, Boston, for 3 yrs.; disch. Nov. 13, 1865, order War Dept., as of Co. "B" 17th V. R. C. See Co. "C" 17th Mass. Inf.

Lang, Charles — Priv., V. R. C. — Res. Gloucester, Mass.; credit Harwich, Mass.; 26; shoemaker; enl. and must. Dec. 20, 1864, Boston, for 3 yrs.; disch. Nov. 16, 1865, as Private, Co. "I" 10th V. R. C. See Co. "A" 17th Mass. Inf.

### MASS. OFFICERS IN UNITED STATES COLORED TROOPS

Jones, Asa L. — Res. Harwich — Promoted to U. S. Col. Inf. Sept. 15, 1863, from 39th Mass. Inf. Resigned as 2d Lieut., 6th U. S. Col. Inf., Sept. 22, 1864. See Co. "A" 39th Mass. Inf.

Megathlin, Anthony S. — Res. Harwich — Promoted to U. S. Col. Inf. Nov 4, 1861, Steamer Flambeau

### MASS. SOLDIERS IN UNITED STATES COLORED TROOPS

Beecher, Barney — Priv., Co. "F" 52d U. S. Col. Inf. — Res. —; credit Harwich, Mass.; 20; farmer; enl. Feb. 21, 1865; must. Feb. 24, 1865, Vicksburg, Miss., for 3 yrs.; must, out May 5, 1866.

Beecher, Nelson — Priv., Co. "F" 52d U. S. Col. Inf. — Res. —; credit Harwich, Mass.; 22; farmer; enl. Feb. 21, 1865; must. Feb. 24, 1865, Vicksburg, Miss., for 3 yrs.; must, out May 5, 1866.

Evens, Caesar — Priv., Co. "I" 37th U. S. Col. Inf. — Res. —; credit Harwich, Mass.; 19; laborer; enl. and must. Aug. 22, 1864, Newbern, N. C.; must, out Feb. 11, 1867.

### ENLISTED MEN IN THE UNITED STATES NAVY

Adams, Henry — 22; occu. —; enl. May 17, 1864, at New Bedford, for 2 yrs., credit Harwich. Served on Regg. Ship Ohio and U. S. S. Santiago de Cuba. Disch. Aug. 1, 1864, from hospl. Norfolk, Va., as Ord. Seaman.

Baker, Henry — 34; occu. -; enl. Dec 23, 1863, for 2 yrs., Acting Ensign, credit Harwich. Served USS Ohio, USS Rosco North Atlantic Squadron. Disch. Nov 3, 1865.

Baker, George W - 34; occu. -; enl. Sep 23, 1863, for 3 yrs., Acting Ensign, credit Harwich. Served USS Ohio, USS Bohio, USS Vandalia, West Gulf Squadron. Disch. Feb 18, 1868.



## Civil War Memorial for the Town of Harwich

Baker, Leonard N. — 25; seaman; enl. Dec 31, 1861, at Boston, for 3 yrs., as Seaman, credit Harwich. USS Ohio, USS Constellation. Disch Jan 25, 1865.

Bazin, Fillipe — 26; seaman; enl. May 18, 1864, at New Bedford, for 3 yrs., as Seaman, credit Harwich. Served on Regg. Ship Ohio and U. S. S. Santiago de Cuba, to June 17, 1865, when transf. to Princeton, as Ord. Seaman. Never reported on Princeton.

Bee, Benjamin F — 28; seaman; enl. Aug 1862, for 3 yrs., as Seaman, credit Harwich. Disch 1865. US Civil War Pension Nov 15, 1882.

Bunker, Lewis — 29; occu. —; enl. Aug. 18, 1862, at Portsmouth, N. H., for 1 yr., as Landsman, credit Harwich. Served on Regg. Ship Ohio, U. S. S. Monongahela, and Pensacola, from which disch. May 10, 1864, as Landsman.

Burnham, George W. — 40; occu. —; enl. May 20, 1864, at New Bedford, for 2 yrs., as Ord. Seaman, credit Harwich. Served on Regg. Ship Ohio and U. S. S. fort Donelson. Disch. Sept. 10, 1865, from Ohio, as Seaman. See Co. "G" 29th Mass. Inf.

Chadwick, John — 20; occu. —; enl. May 24, 1864, at New Bedford, for 2 yrs., as Landsman, credit Harwich. Served on Regg. Ship Ohio, U. S. S. New Hampshire, and Montauk. Disch. Aug. 23, 1865, from Ohio, as Landsman.

Chaplin, David — 29; occu. —; enl. Aug. 19, 1862, at Boston, for 1 yr., as Seaman, credit Harwich. Served on Regg. Ship Ohio, U. S. S. Sabine, Keokuk, and Montauk. Disch. Aug. 25, 1863, from Princeton, as Seaman.

Chase, Leander C. 21; occu. —; enl. Jun 1861, at New Bedford, for 2 yrs., as Seaman, credit Harwich.

Coleman, John — 23; brass finisher; enl. Aug. 16, 1862, at Boston, for 1 yr., as Ord. Seaman, credit Harwich. Served on Regg. Ship Ohio and U. S. S. crusader, from which disch. Aug. 15, 1863, as Ord. Seaman. See enlist. May 9, 1861, as John B. Coleman.

Corey, John R. — 23; occu. —; enl. Aug. 20, 1862, at Boston, for 1 yr., as Landsman, credit Harwich. Served on Regg. Ship Ohio and U. S. S. keystone state, from which disch. June 20, 1863, as Landsman.

Nickerson, Joseph — 21; occu. —; enl. May 2, 1864, at New Bedford, for 2 yrs., as Seaman, credit Harwich. Served on Regg. Ship Ohio, U. S. S. Cibcassian, and Kennebec. Disch. Aug. 23, 1865, from Ohio, as Seaman.

Downs, William — 23; occu. —; enl. May 17, 1864, at New Bedford, for 3 yrs., as Seaman, credit Harwich. Served on Regg. Ship Ohio, U. S. S. fort Donelson, Shenandoah, and Hartford, from which disch. Aug. 14, 1868, as Seaman.

Ellis, William H. — 25; occu. —; enl. Dec. 31, 1861, at Boston, for 2 yrs., as Ord. Seaman, credit Harwich. Served on Regg. Ship Ohio and U. S. S. Penobscot. Disch. April 24, 1862, from Ohio, as Ord. Seaman.

Fleet, John — 21; weaver; enl. July 6, 1864, at Boston, for 2 yrs., as Landsman, credit Harwich. Served on Regg. Ship Ohio, U. S. S. Kittatinny, and Sciota. Disch. Oct. 16, 1865, from North Carolina, as Landsman.

Francis, Alexander — 22; moulder; enl. Aug. 8, 1862, at Boston, for 1 yr., as Landsman, credit Boston. Served on Regg. Ship Ohio and U. S. S. galena. Disch. June 17, 1863, from Princeton, as Landsman. Again

## Civil War Memorial for the Town of Harwich

enlist. June 20, 1864, at Boston, for 3 yrs., as Seaman, credit Harwich. Served on Recg. Ship Ohio and U. S. S. Clyde. Disch. Aug. 16, 1865. Served as substitute.

Fuller, Joseph — 27; currier; enl. May 5, 1864, at New Bedford, for 3 yrs., as Ord. Seaman, credit Harwich. Served on Recg. Ship Ohio, U. S. S. Circassian, Tacony, and Peoria, from which disch. July 22, 1867, as Ord. Seaman.

Gateley, James — 28; occu. —; enl. May 16, 1861, at New Bedford, for 2 yrs., as Seaman, credit Harwich. Served on Recg. Ship Ohio and U. S. S. Sabine. Disch. May 15, 1866, from OHIO, as Seaman.

Goldey, Charles M. — 24; occu. —; enl. May 10, 1864, at New Bedford, for 3 yrs., as Landsman, credit Harwich. Served on Recg. Ship Ohio, U. S. S. Saco, Bat, Mahopac, and Ascutney, from which disch. May 20, 1867, as Yeoman.

Grant, Timothy — 22; occu. —; enl. May 9, 1864, at New Bedford, for 2 yrs., as Ord. Seaman, credit Harwich. Served on Recg. Ship Ohio and U. S. S. azalea. Disch. Aug. 5, 1865, from Princeton, as Ord. Seaman.

Harris, Elijah — 21; occu. —; enl. April 25, 1864, at New Bedford, for 3 yrs., as Seaman, credit Harwich. Served on Recg. Ship Ohio, U. S. S. Philippi, and Tennessee. Died Nov. 22, 1864, on Tennessee, as Seaman.

Healy, William — 21; weaver; enl. July 6, 1864, at New Bedford, for 2 yrs., as Landsman, credit Harwich. Served on Recg. Ship Ohio, U. S. S. Monongahela, Richmond, grand gulf, Potomac, and Aroostook, from which disch. Sept. 22, 1865, as Landsman.

Hill, Arthur H. — 24; cook and steward; enl. June 22, 1864, at New Bedford, for 3 yrs., as Landsman, credit Harwich. Served on Recg. Ship Ohio and U. S. S. Sabine, from which disch. July 15, 1865, at New York, as Warrant Officer's Cook. Served as substitute.

Kelsen, Peter — 21; occu. —; enl. May 5, 1864, at New Bedford, for 2 yrs., as Ord. Seaman, credit Harwich. Served on Recg. Ship Ohio, U. S. S. courier, and Memphis, from which disch. Feb. 5, 1866, as Ord. Seaman.

Kimball, George W. — 21; occu. —; enl. Dec. 17, 1861, at Boston, for 2 yrs., as Ord. Seaman, credit Harwich. Served on Recg. Ship Ohio, U. S. S. Kennebec, Colorado, and Ports- mouth, from which disch. Jany. 9, 1865, as Coxswain. Had re-enlisted Jany. 9, 1864, for 1 yr.

Leonard, James — 24; plumber; enl. Jany. 20, 1862, at Boston, for 2 yrs., as Ord. Seaman, credit Harwich. Served on Recg. Ship Ohio and U. S. S. Kineo. Disch. Nov. 29, 1862, from Ohio, for disab., as Ord. Seaman.

Lovejoy, Oscar D. — 26; occu. —; enl. Dec. 28, 1861, at Boston, for 2 yrs., as Seaman, credit Harwich. Served on Recg. Ship chic, U. S. S. Maratanza, and Sacramento, from which disch. Sept. 26, 1863, as Seaman. Again enlist. Dec. 29, 1863, at Boston, for 1 yr., as Lands- man, credit Somerville. Served on Recg. Ship Ohio, from which disch. July 28, 1864, by order, as Landsman.

Lufkin, John — 18; occu. —; enl. Jany. 28, 1862, at Boston, for 3 yrs., as 2d Class Fireman, credit Harwich. Served on Recg. Ship Ohio, U. S. S. Katahdin, and Inst. Ship Savannah. Disch. March 8, 1865, from North Carolina, as 2d Class Fireman.

## Civil War Memorial for the Town of Harwich

Lynch, John — 20; occu. —; enl. June 25, 1864, at New Bedford, for 3 yrs., as Landsman, credit Harwich. Served on Regg. Ship Ohio, U. S. S. Sabine, Colorado, and Mohongo, from which disch. June 25, 1867, as Landsman.

Merrell, Henry G. — 27; plumber; enl. May 20, 1864, at New Bedford, for 2 yrs., as Ord. Seaman, credit Harwich. Served on Regg. Ship Ohio, U. S. S. Santiago de Cuba, and Ino. Disch. March 21, 1865, from hospl., Boston, for disab., as Ord. Seaman.

Minikin, John — 21; thread dresser; enl. July 6, 1864, at New Bedford, for 2 yrs., as Landsman, credit Harwich. Served on Regg. Ship Ohio, U. S. S. Kittatinny, Sciota, and pink. Disch. as of date May 25, 1865.

Morgan, John — 32; sailmaker; enl. Dec. 18, 1861, at Boston, for 3 yrs., as Seaman, credit Harwich. Served on Regg. Ships Ohio and constellation, from which disch. Jany. 25, 1865, as Sailmaker's Mate.

Munroe, Charles S. — 18; occu. —; enl. Dec. 18, 1861, at Boston, for 3 yrs., as Ord. Seaman, credit Harwich. Served on Regg. Ship Ohio, U. S. S. Hartford, and Miami, from which disch. Dec. 21, 1863, as Ord. Seaman. See Co. "C" 5th Mass. Cav.

Murphy, Alvin — 23; fisherman; enl. April 25, 1864, at New Bedford, for 2 yrs., as Seaman, credit Harwich. Served on Regg. Ship Ohio, U. S. S. Philippi, Tennessee, and Fort Hindman, from which disch. Aug. 5, 1865, as Seaman.

Murphy, Maurice — 24; brush maker; enl. May 14, 1864, at New Bedford, for 2 yrs., as Landsman, credit Harwich. Served on Regg. Ship Ohio, U. S. S. Sabine, Rodolph, fear not, and Tallapoosa, from which disch. May 15, 1866, as Landsman.

Nickerson, George W. — 18; occu. —; enl. Dec. 31, 1861, at Boston, for 3 yrs., as Landsman, credit Harwich. Served on Regg. Ship Ohio, U. S. S. Hartford, and Rhode Island, from which deserted June 10, 1862, at Boston, as Landsman. See Co. "A" 58th Mass. Inf

Nightingale, Charles W. — 26; nailer; enl. Jany. 7, 1862, at New Bedford, for 3 yrs., as Seaman, credit Harwich. Served on Regg. Ship Ohio, U. S. S. Vermont, and New Hampshire. Disch. Jany. 21, 1865, from Ohio, as Captain of Hold.

Nye, Levi W. — 25; occu. —; enl. Jany. 7, 1862, at Bangor, Me., for 3 yrs., as Seaman, credit Harwich. Served on Regg. Ship Ohio and U. S. S. Kearsarge, from which disch. Nov. 30, 1864, as Seaman.

Oakes, Electrus — 28; moulder; enl. Jany. 13, 1862. at Bangor, Me., for 3 yrs., as Ord. Seaman, credit Harwich. Served on Regg. Ship Ohio, U. S. S. Vermont, and Beauregard. Disch. March 18, 1865, from Savannah, as Ord. Seaman.

O'Donnell, Michael — 22; coal heaver; enl. Dec. 24, 1861, at Boston, for 3 yrs., as Landsman, credit Harwich. Served on Regg. Ship Ohio and U. S. S. Aroostook, from which disch. Feb. 1, 1865, as Coal Heaver.

O'Neil, Michael — 20; occu. —; enl. July 12, 1864, at New Bedford, for 3 yrs., as Landsman, credit Harwich. Served on Regg. Ship Ohio and U. S. S. Potomac. Disch. July 11, 1867, and appointed Paymaster's Steward, July 12, 1867. Disch. Aug. 28, 1867, from Potomac, as Paymaster's Steward.

## Civil War Memorial for the Town of Harwich

Oronond, Thomas — 35; occu. —; enl. Dec. 16, 1861, at Boston, for 3 yrs., as Ord. Seaman. credit Harwich. Served on Recg. Ship Ohio and U. S. S. Hartford, from which disch, Dec. 25, 1864, as Ord. Seaman.

Preston, Joseph — 34; cook and steward; enl. May 11, 1864, at New Bedford, for 2 yrs., as Ord. Seaman, credit Harwich. Served on Recg. Ship Ohio, U. S. S. Circassian, pursuit, Hartford, and relief, from which disch. Dec. 31, 1866, as Ord. Seaman.

Quinn, Patrick E. — 20; spinner; enl. May 14, 1864, at Boston, for 2 yrs., as Landsman, credit Harwich. Served on Recg. Ship Ohio, U. S. S. Sabine, fear not, and pampero, from which disch. April 7, 1866, as Wardroom Steward.

Renouf, John — 22; occu. —; enl. Sept. 5, 1862, at Boston, for 1 yr., as Landsman, credit Harwich. Served on Recg. Ship Ohio and U. S. S. Lancaster, from which disch. Sept. 18, 1863, as Landsman.

Reynolds, Henry J. — 22; mariner; enl. May 18, 1864, at New Bedford, for 2 yrs., as Seaman, credit Harwich. Served on Recg. Ship Ohio and U. S. S. fort Donelson. Disch. Aug. 30, 1865, from Ohio, as Seaman.

Romero, Charles — 21; cook; enl. May 18, 1864, at New Bedford, for 3 yrs., as Landsman, credit Harwich. Served on Recg. Ship Ohio and U. S. S. Sabine, from which disch. June 29, 1865, as Landsman.

Sebastean, Samuel — 23; occu. —; enl. Aug. 9, 1862, at Boston, for 1 yr., as Landsman, credit Harwich. Served on Recg. Ship Ohio and U. S. S. Mohican, from which disch. May 11, 1864, as Landsman.

Shepard, Thomas — 26; blacksmith; enl. Aug. 5, 1862, at Boston, for 1 yr., as Seaman, credit Harwich. Served on Recg. Ship Ohio and U. S. S. ino. Disch. Nov. 29, 1862, from Ohio, as Seaman.

Sherlock, Patrick — 19; glass blower; enl. June 17, 1864, at New Bedford, for 3 yrs., as Landsman, credit Harwich. Served on Recg. Ship Ohio and West Gulf Squadron, U. S. S. Rodolph and althea. from which disch. Nov. 21, 1865, as Landsman. Served as substitute.

Sherman, Frederick — 22; occu. —; enl. Aug. 5, 1862, at Boston, for 1 yr., as Landsman, credit Harwich. Served on Recg. Ship Ohio and U. S. S. morse, from which disch. Aug. 4, 1863, as Landsman.

Sidley, Joseph — 18; occu. —; enl. Aug. 8, 1862, at Boston, for 1 yr., as Landsman, credit Harwich. Served on Recg. Ship Ohio and U. S. S. ino, from which disch. Sept. 12, 1863, as Landsman.

Simmons, George E. — 21; occu. —; enl. Aug. 8, 1862, at New Bedford, for 1 yr., as Landsman, credit Harwich. Served on Recg. Ship Ohio and U. S. S. midnight. Disch. Oct. 26, 1863, from North Carolina, as Landsman.

Smith, Charles — 38; cooper; enl. May 3, 1864, at New Bedford, for 3 yrs., as Seaman, credit Harwich. Served on Recg. Ship Ohio and U. S. S. Circassian. Disch. May 10, 1865, from Ohio, as Seaman.

Stevens, William — 31; occu. —; enl. April 25, 1864, at New Bedford, for 3 yrs., as Seaman, credit Harwich. Served on Recg. Ship Ohio, U. S. S. Philippi, Tennessee, fear not, Arizona, Oneida, and Recg. Ship Princeton, from which disch. July 5, 1865, as Seaman.

## Civil War Memorial for the Town of Harwich

Steward, Robert — 21; painter; enl. Aug. 7, 1862, at Boston, for 1 yr., as Landsman, credit Harwich. Served on Regg. Ship Ohio and U. S. S. Commodore Barney, from which disch. Aug. 12, 1863, as Landsman. See Co. "K" 19th Mass. Inf., as Hendley, Robert.

Sullivan, Timothy — 24; occu. —; enl. Aug. 7, 1862, at Boston, for 1 yr., as Landsman, credit Harwich. Served on Regg. Ship Ohio, U. S. S. Wachusett, and Decorah, from which disch. Aug. 6, 1863, as 2d Class Fireman.

Taylor, Nathan L. — 26; machinist; enl. July 7, 1864, at New Bedford, for 2 yrs., as Landsman, credit Harwich. Served on Regg. Ship Ohio and U. S. S. Circassian. Disch. Dec. 6, 1864, from hospl., Boston, for disab., as Landsman.

Taylor, William A. — 24; silversmith; enl. Aug. 12, 1862, at Boston, for 1 yr., as Landsman, credit Harwich. Served on Regg. Ship Ohio and U. S. S. hunchback, from which disch. Aug. 16, 1863, as Landsman. See Co. "F" 6th Mass. Mil. (100 days).

Thompson, John — 22; occu. —; enl. Aug. 13, 1862, at Boston, for 1 yr., as Landsman, credit Harwich. Served on Regg. Ship Ohio, from which disch. Aug. 16, 1863, on writ of Habeas Corpus, as Landsman. Claimed as a minor.

Tucker, Henry — 20; barber; enl. Aug. 6, 1862, at Portsmouth, N. H., for 1 yr., as Landsman, credit Harwich. Served on Regg. Ship Ohio, from which disch. Aug. 6, 1863, as Landsman.

Tye, Bernard — 21; iron moulder; enl. Aug. 5, 1862, at Portsmouth, N. H., for 1 yr., as Landsman, credit Harwich. Served on Regg. Ship Ohio, Wilkes Squadron, and U. S. S. Massachusetts. Disch. July 28, 1863, from Princeton, as Coal Heaver.

Upton, Eben — 24; occu. —; enl. Aug. 14, 1862, at Boston, for 1 yr., as Seaman, credit Harwich. Served on Regg. Ship Ohio, U. S. S. Quaker city, and Norfolk Packet. Disch. April 8, 1863, from North Carolina, for disab., as Seaman.

Waite, Joseph T. — 20; machinist; enl. July 7, 1864, at New Bedford, for 3 yrs., as Landsman, credit Harwich. Served on Regg. Ship Ohio and U. S. S. Monongahela, from which disch. April 12, 1865, as Landsman.

Williams, George — 30; occu. —; enl. May 17, 1864, at New Bedford, for 2 yrs., as Ord. Seaman, credit Harwich. Served on Regg. Ship Ohio, U. S. S. Dumbarton, and Santiago de Cuba, from which disch. June 17, 1866, as Seaman.

Civil War Memorial for the Town of Harwich

**DESERTED NOT ON MEMORIAL**

Brown, Henry — Priv. — Res. Harwich; 39; mariner; enl. Feb. 29, 1864; must. April 18, 1864; **deserted** Jany. 23, 1865. Also had service in Co. "B" 12th Conn. Inf.

Cahoon, Thomas Y. — Priv. — Res. Harwich; 19; seaman; enl. Jany. 5, 1864; must. Jany. 14, 1864; **deserted** April 28, 1864, Readville, Mass. See Co. "E" 43d Mass. Inf. (9 mos.).

Chase, Elijah — Priv. — Res. Harwich; 36; mechanic; enl. Dec. 5, 1863; must. Jany. 14, 1864 **deserted** Aug. 12, 1864, while on furlough.

Chase, Franklin P. — 21; occu. —; enl. Dec. 23, 1861, at Boston, for 3 yrs., as Seaman, credit Harwich. Served on Regg. Ship Ohio and U. S. S. Kineo, from which **deserted** Sept. 16, 1862, at New Orleans, La., as Coxswain.

Chase, Henry H. — 21; occu. —; enl. Dec. 23, 1861, at Boston, for 2 yrs., as Seaman, credit West Harwich. Served on Regg. Ship Ohio and U. S. S. Kineo, from which **deserted** Sept. 16, 1862, at New Orleans, La., as Officer's Cook.

Chase, Joseph L. — 23; occu. —; enl. Dec. 31, 1861, at Boston, for 2 j-rs., as Ord. Seaman, credit Harwich. Served on Regg. Ship Ohio and U. S. S. Kineo, from which **deserted** Aug. 26, 1862, at New Orleans, La., as Ord. Seaman.

Chase, Rufus L. — 22; occu. —; enl. Dec. 23, 1861, at Boston, for 3 yrs., as Seaman, credit West Harwich. Served on Regg. Ship Ohio and U. S. S. Kineo, from which **deserted** Aug. 26, 1862, at New Orleans, La., as Quartermaster.

Crawford, Montgomery N. — 24; painter; enl. Aug. 19, 1862, at Boston, for 1 yr., as Landsman, credit Harwich. Served on Regg. Ship Ohio, U. S. S. Brandtwine, and hetzel. **Deserted** Jany. 27, 1863, from Louisiana, as Landsman.

Eldridge, Zelotes — 23; occu. —; enl. Dec. 31, 1861, at Boston, for 2 yrs., as Ord. Seaman, credit Harwich. Served on Regg. Ship Ohio and U. S. S. Kineo, from which **deserted** Jany. 31, 1864, at Baltimore, Md., as Seaman.

Hines, Moses — Priv., Co. "D" 37th U. S. Col. Inf. — Res. —; credit Harwich, Mass.; 34; farmer; enl. Aug. 20, 1864, Beaufort, N. C. ; must. Aug. 22, 1864, Newbern, N. C.; **deserted** March 6, 1865.

Jackson, Albert — Priv., Co. "D" 5th U. S. Col. Hy. Arty. — Res. —; credit Harwich, Mass.; 20; farmer; enl. Jany. 7, 1865; must. Jany. 16, 1865, Vicksburg, Miss., for 3 yrs.; **deserted** July 23, 1865.

Lache, Edwin M. — 19; occu. —; enl. Jany. 23, 1862, at Portsmouth, N. H., for 3 yrs., aa Lands- man, credit Harwich. Served on Regg. Ship Ohio, U. S. S. Vermont, and Augusta. **Deserted** Oct. 1, 1863, from North Carolina, as Ord. Seaman.

Lyons, William D. — 19; occu. —; enl. Jany. 6, 1862, at Boston, for 3 yrs., as Landsman, credit Harwich. Served on Regg. Ship Ohio, U. S. S. Vermont, and Pocahontas, from which **deserted** Sept. 27, 1862, as Landsman.

## Civil War Memorial for the Town of Harwich

Lyons, William D. — 19; occu. —; enl. Jany. 6, 1862, at Boston, for 3 yrs., as Landsman, credit Harwich. Served on Regg. Ship Ohio, U. S. S. Vermont, and Pocahontas, from which **deserted** Sept. 27, 1862, as Landsman.

Nickerson, George W. — 18; occu. —; enl. Dec. 31, 1861, at Boston, for 3 yrs., as Landsman, credit Harwich. Served on Regg. Ship Ohio, U. S. S. Hartford, and Rhode Island, from which **deserted** June 10, 1862, at Boston, as Landsman. See Co. "A" 58th Mass. Inf.

Nowlan, Thomas — 18; occu. —; enl. Jany. 20, 1862, at Boston, for 3 yrs., as Landsman, credit Harwich. Served on Regg. Ships Ohio and North Carolina, U. S. S. Vermont and America to Dec. 31, 1862, when he **deserted**.

Porter, James — 25; occu. —; enl. May 2, 1864, at New Bedford, for 2 yrs., as Seaman, credit Harwich. Served on Regg. Ship Ohio and U. S. S. Circassian, from which **deserted** June 20, 1864, at New Orleans, La., as Boatswain's Mate.

Robbins, Charles A. — Priv. — Res. Harwich; 19; sailor; enl. Jany. 4, 1864; must. Jany. 14, 1864; wounded May 6, 1864, Wilderness, Va.; **deserted** from furlough, Nov. 18, 1864.

Smith, Charles — 24; occu. —; enl. May 2, 1864, at New Bedford, for 2 yrs., as Seaman, credit Harwich. Served on Regg. Ship Ohio and U. S. S. Circassian. **Deserted** Aug. 20, 1864, from OHIO, as Seaman.

Stapleton, John — 27; occu. —; enl. April 25, 1864, at New Bedford, for 1 yr., as Landsman, credit Harwich. Served on Regg. Ship Ohio, U. S. S. courier, and union. **Deserted** Oct. 29, 1864

Steele, Thomas W. — 29; shoemaker; enl. Aug. 7, 1862, at Portsmouth, N. H., for 1 yr., as Landsman, credit Harwich. Served on Regg. Ship Ohio and U. S. S. young boveb, from which **deserted** April 28, 1863, at Baltimore, Md., as Landsman. Also served in Co. "A" 1st N. H. Inf

Taylor, John — 24; mariner; enl. May 2, 1864, at New Bedford, for 2 yrs., as Seaman, credit Harwich. Served on Regg. Ship Ohio and U. S. S. Circassian, from which **deserted** Feb. 4, 1865, as Captain of Forecastle.

Williams, John — 27; mariner; enl. May 19, 1864, at New Bedford, for 2 yrs., as Seaman, credit Harwich. Served on Regg. Ship Ohio, U. S. S. Sabine, Dumbarton, azalea, and Thomas Freeborn. **Deserted** Nov. 18, 1865, from Vanderbilt, at St. Thomas, W. I., as Seaman.

Wilson, John — 21; occu. —; enl. May 14, 1864, at New Bedford, for 2 yrs., as Ord. Seaman, credit Harwich. Served on Regg. Ship Ohio, from which **deserted** June 18, 1864, as Ord. Seaman.

## Revolutionary War Memorial for the Town of Harwich, Massachusetts

### Volume 1: A-BER

**Allen, John**, Harwich. Return of men enlisted into Continental Army from Capt. Abijah Bangs's co., 2d Barnstable Co. regt., dated Feb. 24, 1778; joined Capt. George Webb's co. Col. William Shepard's regt.; enlistment, 3 years, to expire in 1780; also. Private, Capt. Webb's (3d) co. Col. Shepard's regt.; Continental Army pay accounts for service from Feb. 2, 1777, to Dec. 31, 1779; reported as serving 21 mos. as Private, 13 mos. 29 days as Corporal ; also, muster roll for Oct., 1778, dated Camp at Providence; reported on furlough; also, muster roll dated Providence, May 5, 1779; also. Corporal, Capt. David Holebrook's co. Col. Shepard's (4th) regt. ; Continental Army pay accounts for service from Jan. 1, 1780, to Feb. 2, 1780.

**Aray, John**. List of 6 months men raised by the town of Harwich for service in the Continental Army during 1780. [See Joshua Ary.]

Aray, John, Harwich. Descriptive list of men raised to reinforce Continental Army for the term of 6 months, agreeable to resolve of June 5, 1780 ; age, 16 yrs. ; stature, 4 ft. 11 in.; complexion, light; residence, Harwich; arrived at Springfield July 19, 1780 ; marched to camp July 19, 1780, under command of Capt. Clark.

**Ary, Joshua**, Harwich. Pay roll for 6 months men raised by the town of Harwich for service in the Continental Army during 1780; marched July 8, 1780; discharged Dec. 8, 1780; service, 5 mos. 15 days. [See John Aray.] **AREY**

**Atwood, Bangs**, Harwich. Return of men enlisted into Continental Army from Capt. Abijah Bangs's co., 2d Barnstable Co. regt., dated Feb. 24, 1778; joined Capt. G. Webb's CO., Col. Shephard's regt. ; enlistment, 8 months, to expire Jan. 10, 1778; reported deceased.

**Baker, Samuel**, Harwich. Private, Capt. Abijah Bangs's co. Col. Nathaniel Freeman's regt. ; marched on a secret expedition to Rhode Island Oct. 1, 1777; service, 31 days ; also, return of men enlisted into Continental Army from Capt. Bangs's co., 2d Barnstable Co. regt., dated Feb. 24, 1778; joined Capt. G. Webb's CO., Col. Shephard's regt. ; enlistment to expire 1780.

**Baker, Stephen**, Harwich. Corporal, Capt. Abijah Bangs's co. Col. Nathaniel Freeman's regt.; marched on a secret expedition to Rhode Island Oct. 1, 1777; service, 31 days.

**Bang, Benjamin**. Corporal, Capt. Benjamin Berry's co., Maj. Zenas Winslow's regt.; marched on an alarm at Bedford and Falmouth Sept. 7, 1778; service, 7 days; company made up from Harwich militia.

**Bang, Edward**. Sergeant, Capt. Benjamin Berry's co., Maj. Zenas Winslow's regt.; marched on an alarm at Bedford and Falmouth Sept. 7, 1778; service, 7 days; company made up from Harwich militia.

**Bangs, Abijah**, Harwich. Captain, 3d (also given 8th) Harwich co., 2d Barnstable Co. regt.; list of officers of Mass. militia; commissioned April 20, 1776; also, list of officers chosen from Col. Freeman's and Col. Doane's regts. to reinforce the Lines in and about Boston; endorsed "letter from Joseph Otis, Sept., 1776;" also, Col. Nicholas Dike's regt. ; return for travel allowance sworn to Nov. 26, 1776; company raised for defense of Boston; also, return of men in service from Dec. 1, 1776, to March 1, 1777; stationed at Dorchester Heights; reported commissioned Dec, 1776; also, pay abstract for gun and blanket money, dated Boston, Feb. 24, 1777 ; also, Col. Nathaniel Freeman's regt. ; marched on a secret expedition to Rhode Island Oct. 1, 1777; service, 31 days; also, Maj. Zenas Winslow's regt.; pay abstract for 7 days service in Sept., 1778; marched on alarms at Bedford and Falmouth ; also, pay abstract for 2 days service from Nov. 7, 1778, guarding prisoners from the ship " Somerset " at Harwich and from thence to Yarmouth ; also, pay abstract for 2 days service from Nov. 9, 1778, guarding prisoners from the ship " Somerset" at Harwich and from thence to Barnstable.

**Bangs, Dean**, Harwich. Private, Capt. Abijah Bangs's co. Col. Dike's regt.; return of men in service from Dec. 13, 1776, to March 1, 1777; also, pay abstract for gun and blanket money dated Boston, Feb. 24, 1777.



## Revolutionary War Memorial for the Town of Harwich, Massachusetts

**Bangs, Ebenezer.** Private, Capt. Abijah Bangs's co., Maj. Zenas Winslow's (2d Barnstable Co.) regt.; service, 5 days, in Sept., 1778; marched on alarms at Bedford and Falmouth; also, pay abstract for 2 days service from Nov. 7, 1778, guarding prisoners from the ship "Somerset" at Harwich and from thence to Yarmouth.

**Bangs, Isaac.** 2d Lieutenant, Capt. Benjamin Berry's (1st Harwich) 3d co., 2d Barnstable Co. regt.; list of officers of Mass. militia; commissioned April 20, 1776.

**Bangs, John.** Private, Capt. Benjamin Berry's co., Maj. Zenas Winslow's regt.; marched on an alarm at Bedford and Falmouth Sept. 7, 1778; service, 6 days; company made up from Harwich militia.

**Bangs, Thomas,** Harwich. Private, Capt. Abijah Bangs's co., Col. Dike's regt.; pay abstract for gun and blanket money, dated Boston, Feb. 24, 1777; also, return of men in service from Dec. 13, 1776, to March 1, 1777; also, pay abstract for 2 days service from Nov. 9, 1778, guarding prisoners from the ship "Somerset" at Harwich and from thence to Barnstable.

**Baptiss, John,** Harwich. Private, Capt. Abijah Bangs's co., Col. Dike's regt.; return of men in service from Dec. 13, 1776, to March 1, 1777.

**Barker, Samuel,** Harwich. Private, Capt. Matthias Tobey's co., Col. Aaron Willard's regt.; return for mileage from Fort Edward to Harwich, dated Boston, Jan., 1777; also, pay abstract for mileage, etc., to Ticonderoga, dated Boston, Jan. 15, 1777.

**Beeman, Abraham,** Harwich. Private, Capt. Abijah Bangs's co. Col. Dike's regt.; return of men in service from Dec. 3, 1776, to March 1, 1777.

**Berry, Benjamin,** Harwich. Captain, 3d (1st Harwich) co., 2d Barnstable Co. regt.; list of officers of Mass. militia; commissioned April 20, 1776; also, Maj. Zenas Winslow's regt.; pay roll for 7 days service at Bedford and Falmouth on the alarm of Sept. 7, 1778.

**Berry, Elisha,** Harwich. Descriptive list of men raised to reinforce Continental Army for the term of 6 months agreeable to resolve of June 5, 1780; age, 17 yrs.; stature, 5 ft. 10 in.; complexion, ruddy; residence, Harwich; arrived at Springfield July 19, 1780; marched to camp Jul 19, 1780, under command of Capt. Clark; also, list of men raised for the 6 months service and returned by Brig. Gen. Paterson as having passed muster, in a return dated Camp Totoway, Oct. 25, 1780; also, pay roll for 6 months men raised by the town of Harwich for service in the Continental Army during 1780; marched July 8, 1780; discharged Dec. 13, 1780; service, 5 mos. 20 d.

Bearrey, Elisha. Private, Capt. Abijah Bangs's co.; pay abstract for 2 days service dated Harwich, Nov. 7, 1778, guarding prisoners from the ship "Somerset" at Harwich and thence to Yarmouth.

**Berry, Jonathan,** Harwich. Sergeant, Capt. Abijah Bangs's co. Col. Dike's regt.; return of men in service from Dec. 13, 1776, to March 1, 1777; also, Capt. Benjamin Berry's co., Maj. Zenas Winslow's regt.; pay roll for 7 days service on an alarm at Bedford and Falmouth, Sept. 7, 1778.

Berrey, Jonathan. Sergeant, Capt. Abijah Bangs's co.; pay abstract for 2 days service from Nov. 7, 1778, guarding prisoners from the ship "Somerset" at Harwich and from thence to Yarmouth.

**Berry, Judah.** Corporal, Capt. Benjamin Berry's co., Maj. Zenas Winslow's regt.; pay roll for 7 days service at Bedford and Falmouth, on the alarm of Sept. 7, 1778; company detached from Harwich militia.

**Berry, Scottom.** Private, Capt. Benjamin Berry's co., Maj. Zenas Winslow's regt.; pay roll for 6 days service at Bedford and Falmouth on the alarm of Sept. 7, 1778; company detached from Harwich militia.

Bearry, Scato. Private, Capt. Abijah Bangs's co.; pay abstract for 2 days service dated Harwich, Nov. 7, 1778, guarding prisoners from the ship "Somerset" at Harwich and thence to Yarmouth.

## Revolutionary War Memorial for the Town of Harwich, Massachusetts

### Volume 2: BES-BYX

**Blachford, David**, Harwich. Return of men enlisted into Continental Army from Capt. Abijah Bangs's co., 2d Barnstable Co. regt., dated Feb. 24, 1778; residence, Harwich; enlisted for town of Harwich; joined Capt. George Webb's co., Col. Shepard's regt. ; enlistment to expire in 1780 ; also, Private, Capt. Webb's (Light Infantry) co., Col. William Shepard's (4th) regt. ; muster roll for Feb., 1782, dated Huttts.

Bladford {alias Blancford}, David, Harwich. Private, Capt. Holebrook's co., Col. Shepard's regt.; Continental Army pay accounts for service from Jan. 1, 1780, to Dec. 31, 1780; reported as serving half the time in Capt. Webb's co. ; also, Capt. Webb's CO., Col. Shepard's regt. ; return dated West Point, Dec. 31, 1780

Blanchford, David, Harwich. Capt. George Webb's co., Col. William Shepard's regt. ; muster return [3'ear not given] ; residence, Harwich ; enlisted for town of Harwich; mustered by Joseph Otis, Muster Master; also, Private, Capt. Webb's CO., Col. Sheppard's regt. ; Continental Army pay accounts for service from May 15, 1777, to Dec. 31, 1779 ; enlistment, during war ; also, muster roll for Oct., 1778, dated Camp at Providence; enlisted May 14, 1777; also, muster roll for March and April, 1779, dated Providence.

Blatchford, David, Harwich. List of men mustered in Barnstable Co. by Joseph Otis, Muster Master, as returned May 31, 1777; Capt. George Webb's co., Col. Shepherd's regt.; residence, Harwich; mustered May 29, 1777; enlistment, 3 years

**Blossom, Ezra**. Private, Capt. Elijah Smalley's co., Maj. Zenas Winslow's regt. ; pay roll for 4 days service; marched on an alarm at Bedford and Falmouth in Sept., 1778; also, Capt. Benjamin Berry's (Harwich) co., Maj. Winslow's regt.; pay roll for 5 days service at Bedford and Falmouth on the alarm of Sept. 7, 1778.

**Borges, Stephen**, Harwich. 3d Lieutenant, Capt. Abijah Bangs's co. Col. Nathaniel Freeman's regt.; payroll for Oct., 1777; service, 31 days; marched on a secret expedition to Rhode Island.

**Broadbrooks, Ebenezer**. Private, Capt. Elijah Smalley's co., Maj. Zenas Winslow's regt.; service, 6 days, on an alarm at Bedford and Falmouth in Sept., 1778.

**Broadbrooks, Nathan**, Harwich. Private, Capt. Samuel King's co., Col. Josiah Whitney's regt.; service from July 22, 1776, to Dec. 1, 1776, 4 mos. 13 days, at Hull.

**Broadbrooks, Sylvanus**. Private, Capt. Elijah Smalley's co., Maj. Zenas Winslow's regt.; service, 6 days, on an alarm at Bedford and Falmouth in Sept., 1778.

**Buck, Benjamin**. Private, Capt. Elijah Smalley's co., Maj. Zenas Winslow's regt.; service, 9 days, in Sept., 1778, on an alarm at Bedford and Falmouth.

**Burges (Burgess), Ephraim**, Harwich. Private, Capt. Abijah Bangs's co. Col. Dike's regt.; pay abstract for gun and blanket money dated Boston, Feb. 24, 1777 ; also, Capt. Joseph Griffeth's co.. Col. John Jacobs's regt.; enlisted June 10, 1778; service, 6 mos. 25 days; enlistment to expire Jan. 1, 1779.

Burgess, Ephraim, Harwich. Private, Capt. Abijah Bangs's co. Col. Dike's regt.; service from Dec. 13, 1776, to March 1, 1777.

**Burgess, Peter**, Harwich. Private, Capt. Abijah Bangs's co. Col. Dike's regt.; service from Dec. 13, 1776, to March 1, 1777.

**Burt, James**, Harvard (also given Harwich). Private, Capt. Joseph Sargent's co., drafted from Col. Whitney's and Col. Stearns's regts.; service from May 5, 1777, to July 12, 1777, 67 days, under Gen. Spencer at Rhode Island ; roll sworn to at Boston ; also, Sergeant, Capt. John Drury's co.. Col. Ezra Wood's regt. ; enlisted June 6, 1778 ; discharged Feb. 10, 1779 ; service, 8 mos. 1 day, at North River, N. Y. ; enlistment, 8 months; also, order for wages

## Revolutionary War Memorial for the Town of Harwich, Massachusetts

dated Harvard, June 7, 1779; also, 2d Lieutenant, Col. Nathan Tyler's regt.; list of officers of Mass. militia; commissioned July 6, 1779; regiment detached to serve at Rhode Island until Jan. 1, 1780; also, 2d Lieutenant, Capt. Thomas Fish's co., Col. Nathan Tyler's regt.; engaged July 1, 1779; discharged Dec. 28, 1779; service, 6 mos., at Rhode Island; also, same co. and regt.; pay roll for Dec, 1779, allowing 1 mo. 4 days service at Rhode Island.

### Volume 3: CAA-COR

**Cahoon, Gamaliel**, Harwich. Private, Capt. Abijah Bangs's co.. Col. Nathaniel Fi-ee- man's regt. ; pay roll for Oct., 1777, dated Harwich and sworn to in Suffolk Co. ; service, 31 days, on a secret expedition to Rhode Island; also, Capt. George Webb's CO., Col. William Shepard's (3d) regt. ; muster roll for Oct., 1778, dated Camp at Providence ; discharged Nov. 1, 1778 ; enlistment, 8 months ; also, descriptive list of men raised to reinforce Continental Army for the term of 6 months, agreeable to resolve of June 5, 1780, returned as received of Justin Ely, Commissioner, by Brig. Gen. John Glover, at Springfield, July 22, 1780 ; age, 18 yrs. ; stature, 5 ft. 7 in.; complexion, light; residence, Harwich; marched to camp July 22, 1780, under command of Capt. William Scott; also, list of men raised for the 6 months service and returned by Brig. Gen. Paterson as having passed muster in a return dated Camp Totoway, Oct. 25, 1780; also, pay roll for 6 months men raised by the town of Harwich for service in the Continental Army during 1780; marched July 12, 1780 ; discharged Dec. 13, 1780 ; service, 5 mos. 16 days ; also. Private, Capt. Elnathan Haskell's co. Col. William Shepard's (4th) regt.; muster roll for May, 1781, dated West Point; enlisted Feb. 1, 1781; enlistment, 3 years; also, pay rolls for June-Sept., 1781 ; also, muster rolls for Oct., 1781-Feb., 1782, dated York Hutts; reported on duty at the Lines in Oct. and Nov.,

**Ceasar, Jesse**, Edgartown (also given Harwich and Barnstable). Descriptive list of enlisted men; Capt. William Mills's co., Lieut. Col. John Brooks's regt.; age, 40 (also given 33) yrs.; stature, 5 ft. 5 (also given 5 ft. 6) in.; complexion, mulatto (also given black); hair, black; occupation, boatwright (also given tailor) birthplace, Dukes Co.; residence, Barnstable (also given Harwich and Edgartown); enlisted March -, 1779, by Capt. Coburn ; enlistment, during war; also. Private, Capt. Benjamin Warren's co., Lieut. Col. Brooks's regt. ; muster roll for Feb. and March, 1781, dated West Point; reported on command with artificers; also, (late) Capt. Warren's co., Lieut. Col. Brooks's regt.; muster roll for June, 1781; also, Capt. Mills's co.. Col. John Brooks's (7th) regt.; list of men court- martialled; tried July 16, 1781, by regimental court-martial, Capt. Thorp, President; charged with intoxication on duty; sentence, 100 lashes; also, same co. and regt. ; list of men court-martialled ; tried May 14, 1782 or 1783, by regimental court-martial, Capt. Lincoln, President; charged with intoxication on duty; sentence, 50 lashes; also, same co. and regt.; list of men discharged; discharged June 10, 1783, by Gen. Washington, term of enlistment having expired.

Ceasar, Jesse, Edgartown (also given Barnstable and Harwich). Private, Capt. Benjamin Warren's co., Col. Alden's regt.; muster return dated Albany, Jan. 12, 1778; residence, Edgartown (also given Barnstable and Harwich); enlisted for town of Pembroke; mustered by Ebenezer Smith, Esq., County Muster Master; also, Capt. William Mills's co., Lieut. Col. John Brooks's (7th) regt.; muster roll for July, 1781; enlistment, during war ; also, same co. and regt. muster roll for Sept., 1781 ; reported on command with Col. Putnam ; also, same CO. and regt.; muster rolls for Jan. and -Feb., 1782, dated York Huts.

Ceasar, Jesse, Harwich (also given Barnstable and Edgartown). Return of men enlisted or drafted into Continental Army from Capt. Abijah Bangs's co., 2d Barnstable Co. regt., sworn to in Barnstable Co., Feb. 24, 1778; residence, Harwich (also given Barnstable and Edgartown) ; enlisted for Rhode Island.

Cesar, Jesse, Edgartown (also given Harwich and Barnstable). Private, 3d co. Col. John Brooks's (late Alden's) regt.; Continental Army pay accounts for service from May 19, 1777, to Dec. 31, 1779; also, Capt. Benjamin Warren's co., (late) Col. Ichabod Alden's regt. ; return of men in camp before Aug. 15, 1777, certified to at Cherry Valley, Feb. 24, 1779; also, Capt. Asa Coburn's (Light Infantry) CO., (late) Col. Alden's regt. ; muster roll for March and April, 1779, dated Fort Herkimer; also, 3d co., Col. Brooks's regt. ; Continental Army pay accounts for i , service from Jan. 1, 1780, to Dec. 31, 1780; also, Capt. Warren's co.,

## Revolutionary War Memorial for the Town of Harwich, Massachusetts

Lieut. Col. V Brooks's (7th) regt.; muster roll for April, 1781, dated West Point; also, (late) Capt. Warren's co., Lieut. Col. Brooks's regt.; muster roll for May, 1781, dated West Point ; reported on extra duty.

Cezar, Jesse, Edgartown (also given Harwich and Barnstable). Return of men enlisted into Continental Army from Capt. John Ford's (14th) co. Col. John Cushing's (2d Plymouth Co.) regt., dated Pembroke, Feb. 16, 1778; residence, Edgar- town (also given Barnstable and Harwich); enlisted for town of Pembroke enlistment, 3 years.

**Chase, David**, Harwich. Private, Capt. Samuel King's co. Col. Josiah Whitney's regt. ; order for advance pay dated Hull, June 20, 1776 ; also, petition dated Hull, Oct. 30, 1776, signed by said Chase and others, for compensation on account of having subsisted themselves for 7 days, in consequence of having been delayed in rejoining regiment at Hull by stress of weather, etc., they having been ordered by a resolve of June 8, 1776, to proceed on board sloop " Betsy " to Falmouth, Casco Bay, as guards over cannon, etc., forwarded to that place; petition certified by Col. Josiah Whitney; also, Capt. King's co., Col. Whitney's regt.; service from May 23, 1776, to Dec. 1, 1776, 6 mos. 12 days, at Hull ; also, return of men enlisted into Continental Army from 2d Barnstable Co. regt., as returned by Maj. Zenas Winslow and Capt. Abijah Bangs, sworn to Feb. 24, 1778 ; residence, Harwich ; enlisted for town of Harwich ; joined Capt. George Webb's co., Col. Shephard's regt. ; enlistment, 3 years, to expire in 1780; reported mustered by James Otis, Muster Master, March 11, 1777 ; also. Corporal, Capt. Webb's co. Col. Sheppard's (3d) regt.; Continental Army pay accounts for service from Feb. 1, 1777, to Dec. 31, 1779; reported as serving 29 mos. as Corporal, 6 mos. as Private; also, muster rolls for Oct., 1778, and March and April, 1779, dated Camp at Providence; enlisted Feb. 2 (also given Jan. 15), 1777; reported on command at "Western shore " in March and April, 1779; also. Private, Capt. Holebrook's CO., Col. Shephard's regt. ; Continental Army pay accounts for service from Jan. 1, 1780, to Dec. 31, 1780; reported as having served only one-half the time in Capt. Holebrook's co. ; also, Capt. George Webb's (Light Infantry) co.. Col. Sheppard's regt.; return made up from Jan. 1, 1780, to Dec. 31, 1780, dated West Point; enlistment, during war; also. Private, Capt. Webb's co. Col. Shepard's (4th) regt.; muster roll for Feb., 1782, dated Hutts.

**Chase, Elkanah**, Harwich. Sergeant, Capt. Seth Clark's (Seacoast) co. ; entered service July 1, 1775 ; discharged Dec. 31, 1775 ; service, 6 mos. 10 days ; roll sworn to in Barnstable Co. ; also, Capt. Samuel King's co.. Col. Josiah Whitney's regt. order for advance pay dated Hull, June 20, 1776 ; also, same co. and regt. ; service from May 23, 1776, to Dec. 1, 1776, 6 mos. 12 days, at Hull.

Chace, David, Harwich. Descriptive list of men re-enlisting between Sept. 30, 1779, and Feb. 23, 1780, dated Bud's Highlands; age, 25 yrs.; stature, 5 ft. 8 in.; complexion, dark brown; hair, dark brown; residence, Harwich; joined Col. William Shepard's regt. ; enlistment, during war ; also, Private, Capt. George Webb's (Light Infantry) co., Col. William Shepard's (4th) regt.; muster rolls for Feb., 1781-Jan., 1782, dated Hutts, 1st Brigade.

**Chase, Job**. Sergeant, Capt. Thomas Nickerson's co., Maj. Zenas Winslow's regt.; service, 9 days, on an alarm at Bedford and Falmouth in Sept., 1778.

**Chase, James**, Harwich. Private, Capt. Benjamin Godfrey's co. Col. John Cushing's regt.; service from Sept. 30, 1776, 1 mo. 24 days, at Rhode Island ; roll dated Newport and sworn to in Barnstable Co. ; also, return of men enlisted into Continental Army from Capt. Abijah Bangs's co., 2d Barnstable Co. regt., as returned by Maj. Zenas Winslow and Capt. Abijah Bangs, sworn to Feb. 24, 1778; residence, Harwich; enlisted for town of Harwich; joined Capt. George Webb's co., Col. Shephard's regt. ; enlistment to expire in 1780 (also given during war) ; reported mustered by Joseph Otis, Muster Master, April 15, 1777 ; also, Fifer, Capt. Joshua Benson's co., Col. Rufus Putnam's (4th) regt. ; Continental Army pay accounts for service from Feb. 10, 1777, to Dec. 31, 1779; reported as serving 32 mos. 21 days as Private, 2 mos. as Fifer; also, Private, same co. and regt.; muster return dated Albany, Feb. -, 1778 ; also, list of deserters dated Nov. 20, 1780 Col. Rufus Putnam's (5th) regt.; age, 19 yrs. ; stature, 5 ft. 5 in. ; complexion,

## Revolutionary War Memorial for the Town of Harwich, Massachusetts

dark; hair, black; residence, Harwich; enlistment, during war; deserted March -, 1780; also, Continental Army pay accounts for service in 1780; reported discharged.

**Chase, Jeremiah**, Harwich. Fifer, Capt. Samuel King's co., Col. Josiah Whitney's regt. ; order for advance pay dated Hull, June 20, 1776; also, same co. and regt. service from May 23, 1776, to Dec. 1, 1776, 6 mos. 12 days, at Hull; also, return of men enlisted into Continental Army from Capt. Abijah Bangs's co., 2d Barnstable Co. regt., as returned by Maj. Zenas Winslow and Capt. Abijah Bangs, sworn to Feb. 24, 1778; residence, Harwich ; enlisted for town of Harwich ; joined Capt. George Webb's co.. Col. Shepard's regt.; enlistment to expire in 1780 (also given during war) ; reported mustered by Joseph Otis, Muster Master ; also, Fifer, Capt. Webb's co., Col. William Shepard's (3d) regt.; Continental Army pay accounts for service from Feb. 2, 1777, to Dec. 31, 1779 ; also, muster rolls for Oct., 1778, and March and April, 1779, dated Camp at Providence ; enlisted Feb. 2 (also given Jan. 15), 1777; also, Capt. Holebrook's co., Col. Shepard's (4th) regt.; Continental Army pay accounts for service from Jan. 1, 1780, to Dec. 31, 1780 ; reported as serving half the time in Capt. Webb's co. ; also, Capt. George Webb's (Light Infantry) co., Col. Shepard's regt. ; return for gratuity dated Highlands, Feb. 24, 1780; also, same co. and regt.; return made up from Jan. 1, 1780, to Dec. 31, 1780, dated West Point.

**Chase, John**, Harwich. List of men mustered in Barnstable Co. by Joseph Otis, Muster Master, dated March 14, 1777; Capt. Webb's co.. Col. Shepard's regt.; residence, Harwich; mustered March 11, 1777; enlistment, during war.

**Chase, Samuel**, Harwich. Private, Capt. Samuel King's co. Col. Josiah Whitney's regt.; order for advance pay, etc., dated Camp at Hull, Aug. 30, 1776 ; also, same CO. and regt. ; service from July 22, 1776, to Dec. 1, 1776, 4 mos. 13 days, at Hull.

**Clark, Andrew**. Private, Capt. Benjamin Berry's (Harwich) co., Maj. Zenas Winslow's regt.; service, 6 days, on an alarm at Bedford and Falmouth Sept. 7, 1778.

**Clark, Barnabas**. Sergeant, Capt. Benjamin Berry's (Harwich) co., Maj. Zenas Winslow's regt.; service, 7 days, on an alarm at Bedford and Falmouth Sept. 7, 1778.

**Clark, David**. Private, Capt. Elijah Smalley's co., Maj. Zenas Winslow's regt.; service, 6 days, on an alarm at Bedford and Falmouth in Sept.,

**Clark, Gideon**. Private, Capt. Benjamin Berry's (Harwich) co., Maj. Zenas Winslow's regt.; service, 7 days, on an alarm at Bedford and Falmouth Sept. 7, 1778.

**Clark, James**. Private, Capt. Benjamin Berry's (Harwich) co., Maj. Zenas Winslow's regt.; service, 2 days, on an alarm at Bedford and Falmouth Sept. 7, 1778.

**Clark, John**, Harwich. Private, Capt. Isaiah Higgins's co, Col. Thomas Marshall's regt.; enlisted June 6, 1776; service to Oct. 3, 1776, 3 mos. 29 days.

Clarke, John, Harwich. Private, Capt. Isaiah Higgins's co., Col. Thomas Marshall's regt.; pay abstract for advance pay for 1 month from June 6, 1776, etc., dated Boston, June 17, 1776.

**Clark, Joseph**. Private, Capt. Benjamin Berry's (Harwich) co., Maj. Zenas Winslow's regt.; service, 6 days, at Bedford and Falmouth on an alarm Sept. 7, 1778. Roll sworn to in Barnstable Co.

**Clark, Josiah**. Private, Capt. Benjamin Berry's (Harwich) co., Maj. Zenas Winslow's regt.; service, 7 days, at Bedford and Falmouth on an alarm Sept. 7, 1778. Roll sworn to in Barnstable Co.

**Clark, Lot**, Harwich. Descriptive list of men raised to reinforce Continental Army for the term of 6 months, agreeable to resolve of June 5, 1780, returned as received of Justin Ely, Commissioner, by Brig. Gen. John Glover, at Springfield, July 19, 1780; age, 17yrs.; stature, 5 ft. ; complexion, light; residence, Harwich ; marched to camp

## Revolutionary War Memorial for the Town of Harwich, Massachusetts

July 19, 1780, under command of Capt. Clark ; also, list of men raised for the 6 months service and returned by Brig. Gen. Paterson as having passed muster in a return dated Camp Totoway, Oct. 25, 1780 ; also, pay roll for 6 months men raised by the town of Harwich for service in the Continental Army' during 1780; marched July 8, 1780; discharged Dec. 13, 1780; service, 5 mos. 20 days.

**Clark, Nathaniel.** Private, Capt. Benjamin Berry's (Harwich) co., Maj. Zenas Winslow's regt.; service, 6 days, at Bedford and Falmouth on an alarm Sept. 7, 1778. Roll sworn to in Barnstable Co.

**Clark, Reuben.** Lieutenant, Capt. Benjamin Berry's (Harwich) co., Maj. Zenas Winslow's regt.; service, 7 days, on an alarm at Bedford and Falmouth Sept. 7, 1778. Roll sworn to in Barnstable Co.

**Clark, Seth.** Captain of a Seacoast company; entered service July 1, 1775; discharged Dec. 31, 1775; service, 6 mos. 16 days. Roll sworn to in Barnstable Co.

**Clark, Scottow.** Sergeant, Capt. Benjamin Berry's (Harwich) co., Maj. Zenas Winslow's regt.; service, 7 days, on an alarm at Bedford and Falmouth Sept. 7, 1778. Roll sworn to in Barnstable Co.

**Clark, Solomon.** Private, Capt. Benjamin Berry's (Harwich) co., Maj. Zenas Winslow's regt.; service, 7 days, on an alarm at Bedford and Falmouth Sept. 7, 1778. Roll sworn to in Barnstable Co.

**Clark, Thacher.** Private, Capt. Benjamin Berry's (Harwich) co., Maj. Zenas Winslow's regt.; service, 7 days, on an alarm at Bedford and Falmouth Sept. 7, 1778. Roll sworn to in Barnstable Co.

**Clark (Clark), Joseph, Jr.** Private, Capt. Abijah Bangs's co.; service, 2 days, guarding prisoners from Br. ship " Somerset " at Harwich and from thence to Yarmouth. Roll dated Nov. 7, 1778.

**Clark (Clark), Sylvanus.** Private, Capt. Abijah Bangs's co. ; service, 2 days, guarding prisoners from Br. ship " Somerset" at Harwich and from thence to Yarmouth. Roll dated Nov. 7, 1778.

**Cobb, Jonathan,** Harwich (also given East Yarmouth). Capt. Abijah Bangs's co. list of men raised in Barnstable Co. dated Dorchester, Sept. 4, 1776; also. Sergeant, Capt. Abijah Bangs's co., Col. Dike's regt.; pay roll for travel allowance to and from camp, etc. ; credited with 4 days allowance ; roll dated Boston, Nov. 26, 1776.

**Coff, Thomas,** Harwich. List of men mustered in Barnstable Co. by James Otis, • Muster Master, dated April 14, 1777; Capt. George Webb's co., Col. Shepard's regt.; mustered April 12, 1777; enlistment, during war. [See Thomas Cuff.]

**Cahoon, Nathaniel Jr.** (also given Jr.), Harwich. Private, Capt. Isaiah Higgins's co. Col. Thomas Marshal's regt.; return for advance pay, etc., for 1 month from June 6, 1776; company reported as at Boston June 17, 1776; also, same co. and regt.; enlisted June 6, 1776; service to Aug. 1, 1776, 1 mo. 6 days(?); also, order for advance pay, travel allowance, etc., dated Long Island, Sept. 2, 1776; also, pay roll ; service from Aug. 19, 1776, to date of discharge, Dec. 1, 1776, 3 mos. 13 days.

**Cahoon, Nathaniel,** Harwich. Private, Capt. Abijah Bangs's co., Col. Nathaniel Freeman's regt.; pay roll for Oct, 1777, dated Harwich and sworn to in Suffolk Co.; service, 31 days, on a secret expedition to Rhode Island; also, return of men enlisted or drafted into Continental Army from 2d Barnstable Co. regt., as returned by Capt. Abijah Bangs and Maj. Zenas Winslow, sworn to Feb. 24, 1778; residence, Harwich; engaged for town of Harwich; joined Capt. G. Webb's co.. Col. Shephard's regt.; term to expire in 1780.

Cahoon (Cahoon), Nathaniel, Harwich. Descriptive list of men raised to reinforce Continental Army for the term of 6 months, agreeable to resolve of June 5, 1780, returned as received of Justin Ely, Commissioner, by Brig. Gen. John Glover, at Springfield, July 20, 1780; age, 44 yrs; stature, 5 ft. 4 in.; complexion, light; residence, Harwich; arrived at Springfield July 19, 1780; marched to camp July 19, 1780, under command of Capt. Clark ; also, pay roll for 6 months men raised by the town of Harwich for service in the

## Revolutionary War Memorial for the Town of Harwich, Massachusetts

Continental Army during 1780; marched July 8, 1780; discharged Aug. 8, 1780; service, 1 mo. 15 days, travel included.

Cohoone, Nathaniel, Harwich. Private, Capt. Benjamin Godfrey's co. Col. Josiah Whitney's regt.; arrived at destination May 10, 1777; discharged July 10, 1777; service, 2 mos. 11 days, at Rhode Island, travel included; company stationed at South Kingston; enlistment, 2 months. Roll dated Boston Neck.

**Cphoon (Cahoon), Reuben**, Harwich. Private, Capt. Abijah Bangs's co., Col. Nathaniel Freeman's regt.; pay roll for Oct., 1777, dated Harwich and sworn to in Suffolk Co.; service, 31 days, on a secret expedition to Rhode Island.

**Collins, Seth**, Chatham. Private, Capt. Abijah Bangs's co., Col. Nathaniel Freeman's regt.; pay roll for

**Cool, John**, Harwich. Private, Capt. Joseph Griffith's co. Col. John Jacobs's regt. enlisted June 20, 1778; service, 6 mos. 25 days, travel included; enlistment to expire Jan. 1, 1779.

**Cook, John**, Harwich. Matross, Capt. John Gill's (6th) co. Col. Thomas Crafts's (Artillery) regt.; abstract for advance pay, etc., sworn to at Boston, June 8, 1776; also, same co. and regt.; enlisted May 9, 1776; service to Nov. 1, 1776, 5 mos. 24 days; also, Matross, Capt. Joseph Balch's (3d) co., Col. Thomas Crafts's (Artillery) regt.; service from Nov. 1, 1776, to Feb. 1, 1777, 3 mos. Roll sworn to in Suffolk Co.

Cooke, John, Harwich. Private, Capt. Joseph Franklin's co. Col. Nathan Tyler's regt.; enlisted Oct. 22, 1779; discharged Dec. 31, 1779; service, 2 mos. 9 days, at Rhode Island.

**Cook, Shubael**. Private, Capt. Benjamin Berry's (Harwich) co., Maj. Zenas Winslow's regt.; service, 7 days, on an alarm at Bedford and Falmouth Sept. 7, 1778. Roll sworn to in Barnstable

### Volume 4: COS-DRY

**Covel, Edward**, Harwich. Private, Capt. Samuel King's co. Col. Josiah Whitney's regt.; service from May 23, 1776, 3 mos. 20 days; reported died Sept. 12, 1776. Rolls dated Camp at Hull.

**Covel, John**, Harwich. Private, Capt. Samuel King's co. Col. Josiah Whitney's regt.; service from Aug. 9, 1776, to Dec. 1, 1776, 3 mos. 26 days; roll dated Camp at Hull; also, petition dated Camp at Hull, Sept. 17, 1776, signed by said Covel and others, asking for increase and payment of wages; also, Capt. Abijah Bangs's CO., Col. Nathaniel Freeman's regt.; pay roll for Oct., 1777; service, 31 days, on a secret expedition to Rhode Island.

**Covel, John, Jr.**, Harwich. Private, Capt. Samuel King's co., Col. Josiah Whitney's regt.; service from Aug. 1, 1776, 1 mo. 5 days; reported died Sept. 5, 1776. Roll dated Camp at Hull.

**Covil, Ephraim**, Harwich. List of men enlisted or drafted into Continental Army from 2d Barnstable Co. regt., as returned by Maj. Zenas Winslow and Capt. Abijah Bangs, dated Feb. 24, 1778; residence, Harwich; engaged for town of Harwich; joined Capt. G. Weeb's (Webb's) co. Col. Shephard's regt.; term to expire in 1780.

Covell, Ephraim, Harwich. Sergeant, Capt. George Webb's co., Col. William Sheppard's regt.; Continental Army pay accounts for service from Jan. 2, 1777, to Dec. 31, 1779; also, Capt. Webb's co. Col. Shepard's (3d) regt.; muster rolls for Oct., 1778, and March and April, 1779, dated Camp at Providence; appointed Jan. 2 (also given Jan. 1), 1777; enlistment, during war; also, Capt. Webb's (Light Infantry) co., Col. Shepard's regt.; muster roll made up to Dec. 31, 1780, dated West Point; also, Ensign, Capt. William Moore's (5th) co., Col. Shepard's regt.; muster roll for Aug., 1781, sworn to at Peekskill; appointed Jan. 1, 1781; reported on command with light infantry; also, muster roll for Sept., 1781, dated Camp Continental Village; reported on command with light infantry; also, muster rolls for Oct., 1781-Feb., 1782, dated York Hutts, and sworn to at West Point; reported on command at the Southward by general orders Oct. 12, 1781; also, returns dated York Hutts, May 10, 1782, Cantonment, 1st Mass. brigade. May 24, 1782, West Point, June 14 and June 24, 1782, Verplanck's Point, various dates between Sept. 13 and

## Revolutionary War Memorial for the Town of Harwich, Massachusetts

Oct. 11, 1782; reported on furlough at Cape Cod from Dec. 13, 1781, by leave of Gen. McDougal ; furlough expired April 10, 1782 ; also, return dated Verplanck's Point, Oct. 25, 1782; reported cashiered since last return.

Covel, Ephraim, Harwich. Sergeant, Capt. Holebrook's co. Col. William Shepard's (4th) regt.; Continental Army pay accounts for service from Jan. 1, 1780, to Dec. 31, 1780; reported as serving half the time in Capt. Webb's co.; also, Capt. Webb's CO., Col. Shepard's regt.; return for gratuity dated Highlands, Feb. 24, 1780; also, Ensign, Col. Shepard's regt.; return of officers dated Oct. 19, 1781; reported on command at the Southward by general order.

Covill, Ephraim, Harwich. List of men mustered by Joseph Otis, Muster Master for Barnstable Co., dated Barnstable, March 14, 1777; Capt. Webb's co., Col. Shepard's regt.; residence, Harwich; mustered March 11, 1777; enlistment, during war; also, Sergeant, Capt. George Webb's (Light Infantry) co., Col. William Shepard's (4th) regt.; muster roll for Feb.-Nov., 1781, dated Hutts, 1st Brigade; reported promoted Aug. 1, 1781.

**Covil, Benjamin**, Harwich. List of men enlisted or drafted into Continental Army from 2d Barnstable Co. regt., as returned by Maj. Zenas Winslow and Capt. Abijah Bangs, dated Feb. 24, 1778 ; residence, Harwich ; engaged for town of Harwich ; joined Capt. G. Weeb's (Webb's) co.. Col. Shephard's regt.; term to expire in 1780.

Covel, Benjamin, Harwich. Private, Capt. Samuel King's co. Col. Josiah Whitney's regt.; service from Aug. 9, 1776, to Dec. 1, 1776, 3 mos. 26 days; roll dated Camp at Hull; also, Capt. David Holebrook's co. Col. William Shepard's (4th) regt.; Continental Army pay accounts for service from Jan. 1, 1780, to Dec. 31, 1780; also, Capt. Webb's co. Col. Shepard's regt.; return for gratuity dated Highlands, Feb. 24, 1780; also, Capt. Holbrook's co. Col. Shepard's regt.; muster rolls for Dec, 1781, and Jan., 1782, dated York Hutts; enlisted March 14, 1777; enlistment, during war; reported on command at Stony Point in Jan., 1782.

Covill, Benjamin, Harwich. List of men mustered by Joseph Otis, Muster Master for Barnstable Co., dated April 14, 1777; Capt. George Webb's co.. Col. Shepard's regt.; residence, Harwich; mustered April 3, 1777; enlistment, during war; also, Private, Capt. George Webb's (Light Infantry) co. Col. William Shepard's (4th) regt.; muster rolls for Feb.-Nov., 1781, dated Hutts, 1st Brigade; also, same co. and regt.; muster roll for Dec, 1781, dated Hutts, 1st Brigade, and sworn to at West Point ; reported transferred to Capt. Holbrook's co.

**Covil, Thomas**, Harwich. List of men enlisted or drafted into Continental Army from 2d Barnstable Co. regt., as returned by Maj. Zenas Winslow and Capt. Abijah Bangs, dated Feb. 24, 1778 ; residence, Harwich ; engaged for town of Harwich; joined Capt. G. Weeb's (Webb's) co.. Col. Shephard's regt.; term to expire in 1780.

Covill, Thomas, Harwich. List of men mustered in- Joseph Otis, Muster Master for Barnstable Co., dated Barnstable, March 14, 1777 ; Capt. Webb's co., Col. Shepherd's regt. ; residence, Harwich ; mustered March 11, 1777; enlistment, during war.

Cowel, Thomas, Harwich. Ensign, Col. William Shepard's regt. ; Continental Army pay accounts for service from March 31, 1779, to Aug. 18, 1779 ; reported resigned Aug. 18, 1779; also. Ensign, Capt. Simon Larned's (8th) co. Col. William Shepard's (3d) regt.; muster roll for March and April, 1779, dated Providence; appointed March 31, 1779; reported on command at Cape Cod; also reported furloughed April 28, 1779, for 10 days by Gen. Glover.

**Crook, James**, Harwich. Descriptive list of men raised to reinforce Continental Army for the term of 6 months, agreeable to resolve of June 5, 1780, returned as received of Justin Ely, Commissioner, by Brig. Gen. John Glover, at Springfield, July 19, 1780; age, 16 yrs. ; stature, 5 ft. 2 in.; complexion, Indian; residence, Harwich; marched to



## Revolutionary War Memorial for the Town of Harwich, Massachusetts

camp July 19, 1780, under command of Capt. Clark ; also, descriptive list of enlisted men dated Feb. 20, 1782 ; age, 19 (also given 18) yrs. ; stature, 5 ft. 5<sup>^</sup> (also given 6 ft. <sup>^</sup>) in.; complexion, Indian; hair, black; occupation, farmer (also given laborer) ; birthplace, Harwich; residence, Harwich; enlisted March 19, 1781 ; joined Capt. Maynard's (also given Capt. Allen's) co., Lieut. Col. John Brooks's (7th) regt. ; enlistment, 3 years ; also, Private, Capt. Jonathan Maynard's CO., Lieut. Col. John Brooks's (7th) regt.; muster roll for May, 1781, dated "West Point; also, muster rolls for June and July, 1781 ; reported on command at West Point ; also, muster roll for Aug., 1781, sworn to at Peekskill ; reported on command at West Point; also, muster rolls for Sept., 1781-Aug., 1782; also, list of men court-martialed; tried Aug. 6, 1782, by regimental court-martial, Capt. Bates, President, on charge of stealing provisions ; sentence, 50 lashes ; also, muster rolls for Oct. and Nov., 1782; also, Capt. Nathaniel C. Allen's (8th) co., Lieut. Col. Brooks's regt. ; muster rolls for Dec, 1782-Sept., 1783 ; term of enlistment unexpired, 6 months.

Croock, James. Pay roll for 6 months men raised by the town of Harwich for service in the Continental Army during 1780; marched July 8, 1780; discharged Jan. 8, 1781; service, 6 mos. 15 days; also, Private, Capt. Thomas Turner's (5th) co., Col. Henry Jackson's (16th) regt. ; service from date of joining, July 19, 1780, to Aug. 1, 1780, 13 days.

Crooks, James, Harwich. List of men raised for the 6 months service and returned by Brig. Gen. Paterson as having passed muster in a return dated Camp Totoway, Oct. 25, 1780.

Crosby. [This name also appears under the form of Crausby, Crobey, Croosby, Crosbay, Crosbe, Crosbee, Crosbey, Crosbie, Crosbury, Crosly, Crosprey, Crossby, Crsby.]

**Crosby, Elisha**, Harwich. Private, Capt. Abijah Bangs's co., Col. Dike's regt. ; pay abstract for gun and blanket money dated Boston, Feb. 24, 1777 ; also, same co. and regt. ; service from Dec. 13, 1776, to March 1, 1777.

**Crosby, Elkanah**, Harwich. Private, Capt. Abijah Bangs's co. Col. Dike's regt.; pay abstract for gun and blanket money dated Boston, Feb. 24, 1777; also, same CO. and regt.; service from Dec. 3, 1776, to March 1, 1777; also, Capt. Abijah Bangs's co., Col. Nathaniel Freeman's regt.; pay roll for Oct., 1777, dated Harwich and sworn to in Suffolk Co.; service, 31 days, on a secret expedition to Rhode Island.

**Crosby, John**, Harwich. Capt. Isaiah Higgins's co., Col. Thomas Marshall's regt.; return for advance pay for 1 mo., etc., of certain men who had joined said company subsequent to June 28, 1776, sworn to in Suffolk Co.; Harwich reported as last place of rendezvous; also, same co. and regt.; order for advance pay for 1 mo., etc., dated Long Island, Sept. 2, 1776; also, Private, Capt. Abijah Bangs's co., Col. Dike's regt. ; pay abstract for gun and blanket money dated Boston, Feb. 24, 1777 ; also, same co. and regt. ; service from Dec. 3, 1776, to March 1, 1777.

Crosbe, John, Harwich. Private, Capt. Isaiah Higgins's co. Col. Thomas Marshall's regt.; enlisted June 20, 1776; service to Dec. 1, 1776, 5 mos. 12 days.

**Crosby, Moses**, Harwich. Private, Capt. Abijah Bangs's co. Col. Dike's regt.; pay abstract for gun and blanket money dated Boston, Feb. 24, 1777; also, same co. and regt.; service from Dec. 3, 1776, to March 1, 1777.

**Crosby, Nathaniel**, Harwich. Private, Capt. Samuel King's co., Col. Josiah Whitney's regt. ; service from May 23, 1776, to Nov. 1, 1776, 5 mos. 8 days, at Hull; also, petition dated Hull, Oct. 30, 1776, signed by said Crosby and others, asking for compensation for subsisting themselves for 7 days in consequence of having been delayed in rejoining regiment at Hull by stress of weather, etc., they having been ordered by a resolve of June 8, 1776, to proceed on board the sloop " Betsy " to Falmouth, Casco Bay, as guards over cannon, etc., forwarded to that place; petition certified by Col. Whitney; also, Capt. King's co.. Col. Whitney's regt.; pay roll for Nov., 1776, allowing 1 mo. 4 days service.

**Crosby, Samuel**. Private, Capt. Benjamin Berry's (Harwich) co., Maj. Zenas Winslow's regt.; service, 5 days, on an alarm at Bedford and Falmouth Sept. 7, 1778.

## Revolutionary War Memorial for the Town of Harwich, Massachusetts

**Crosby, Sparrow**, Harwich. Capt. Samuel King's co.; order for advance wages dated Camp at Hull, Aug. 30, 1776; also, Private, Capt. Samuel King's co. Col. Josiah Whitney's regt.; service from July 26, 1776, to Dec. 1, 1776, 4 mos. 9 days, at Hull; also, Capt. Abijah Bangs's co., Col. Nathaniel Freeman's regt. ; pay roll for Oct., 1777, sworn to in Suffolk Co.; service, 31 days, on a secret expedition to Rhode Island.

**Crosby, Tully**, Harwich. Petition dated Camp at Hull, Sept. 17, 1776, signed by said Crosby and others, asking for increase and payment of wages ; also, Private, » Capt. Samuel King's co.. Col. Josiah Whitney's regt.; service from May 23, 1776, to Dec. 1, 1776, 6 mos. 12 days, at Hull.

Crowell, [This name also appears under the form of Cowel, Crawl, Croall, Croel, Croell, Crouel, Crowel, Crowds, Growl, Crowle.]

**Crowel (Crowell), Edward**, Harwich. Sergeant, Capt. Abijah Bangs's co. Col. Nathaniel Freeman's regt.; service from Oct. 1, to Oct. 31, 1777, 31 days, on a secret expedition to Rhode Island.

**Crowel (Crowell), Grows (Gross)**. Private, Capt Elijah Smalley's co., Maj. Zenas Winslow's regt.; service, 6 days, on an alarm at Bedford and Falmouth in Sept., 1778. Buried Evergreen

**Crowel (Crowell), Seth**, Harwich. Capt. Samuel King's co.; order for wages dated Hull, June 20, 1776; also, Private, Capt. Samuel King's co. Col. Josiah Whitney's regt.; service from Aug. 1, 1776, 1 mo. 4 days; reported died Sept. 4, 1776; roll dated Camp at Hull.

**Crowell, Solomon**. Private, Capt. Seth Clark's (Seacoast) co.; enlisted July 1, 1775; discharged Dec. 31, 1775; service, 6 mos. 5 days. Roll sworn to in Barnstable Co.

**Cuff, Thomas**, Harwich (also given Eastham). Return of men enlisted or drafted into Continental Army from 2d Barnstable Co. regt., as returned by Capt. Abijah Bangs and Maj. Zenas Winslow, dated Feb. 24, 1778; residence, Harwich; engaged for town of Harwich ; joined Capt. George Webb's co.. Col. William Shephard's regt.; term to expire in 1780; also, Private, Capt. Webb's co. Col. Sheppard's regt.; Continental Army pay accounts for service from April 2, 1777, to May 5, 1777; reported deserted; also, Capt. Webb's (4th) co.. Col. Shepard's regt. ; list of deserters made up to June 1, 1780 ; age, 30 yrs. ; stature, 5 ft. 10 in. complexion, negro; residence, Eastham; enlistment, during war; reported deserted May 5, 1777, at Boston, and last heard of with Capt. Manley.

**Davis, John**, Harwich. List of men enlisted or drafted into Continental Army from 2d Barnstable Co. regt., as returned by Maj. Zenas Winslow and Capt. Abijah Bangs, sworn to Feb. 24, 1778; residence, Harwich; engaged for town of Harwich; joined Capt. G. Webb's co.. Col. Shephard's regt.; term to expire in 1780; also, list of men mustered by Joseph Otis, Muster Master for Barnstable Co., dated May 29, 1777; mustered March 15, 1777; term, during war; «^so. Private, Capt. George Webb's co. Col. William Sheppard's regt.; Continental Army pay accounts for service from Jan. 1, 1777, to May 8, 1777; reported deceased.

**Dillingham, John**. Private, Capt. Benjamin Berry's (Harwich) co., Maj. Zenas Winslow's regt.; service, 6 days, on an alarm at Bedford and Falmouth Sept. 7, 1778.

Doane. [This name also appears under the form of Dean, Deen, Doan, Doawne, Doin, Done, Donn, Down.]

**Done (Doane), Elisha**, Harwich. Private, Capt. Joseph Griffith's co., Col. John Jacobs's regt.; enlisted June 10, 1778; service, 6 mos. 25 days, travel included; enlistment to expire Jan. 1, 1779.

### Volume 5: DUR-FOY

**Dyer, John**, Harwich. Descriptive list of men raised to reinforce Continental Army for the term of 6 months, agreeable to resolve of June 5, 1780, returned as received of Justin Ely, Commissioner, by Brig. Gen. John Glover,

## Revolutionary War Memorial for the Town of Harwich, Massachusetts

at Springfield, July 20, 1780; age, 24 yrs.; stature, 5 ft. 4 in.; complexion, light; engaged for town of Harwich; marched to camp July 20, 1780, under command of Capt. Benjamin Warren ; also, list of men raised for the 6 months service and returned by Brig. Gen. Paterson as having passed muster in a return dated Camp Totoway, Oct. 25, 1780 ; also, pay roll for 6 months men raised by the town of Harwich for service in the Continental Army during 1780; marched July 8, 1780; discharged Dec. 13, 1780; service, 5 mos. 20 days.

**Eden, Samuel**, Harwich. Private, Capt. Seth Clark's (Seacoast) co. ; enlisted July 1, 1775; discharged Dec. 31, 1775; service, 6 mos. 8 days, travel included; roll sworn to in Barnstable Co.; also, Capt. Nathaniel Winslow's co., Col. Josiah Whitney's regt. ; company receipt for advance pay for 1 month, travel allowance from home to Boston, etc., dated Point Shirley, June 13, 1776 ; also, petition dated Camp at Hull, Sept. 17, 1776, signed by said Eden and others, asking for increase and payment of wages ; also, Capt. Winslow's co.. Col. Whitney's regt. enlisted May 1, 1776; service to Nov. 1, 1776, 6 mos.; also, pay roll for Nov., 1776, allowing 1 mo. 4 days service, travel included ; also, Capt. Benjamin Berry's (Harwich) co., Maj. Zenas Winslow's regt. ; service, 5 days, on an alarm at Bedford and Falmouth Sept. 7, 1778.

Eldredge, [This name also appears under the form of Elderidge, Eldrage, Eldred, Eldredg, Eldreg, Eldrege, Eldridg, Eldridge, Eldrig, Eldrige, Eldritch, Elridge, Etridge.]

**Eldridge, Obadiah**, Harwich. Descriptive list of men raised to reinforce Continental Army for the term of 6 months, agreeable to resolve of June 5, 1780, returned as received of Justin Ely, Commissioner, by Brig. Gen. John Glover, at Springfield, July 20, 1780 ; age, 18 yrs. ; stature, 5 ft. 8 in. ; complexion, dark; engaged for town of Harwich; marched to camp July 20, 1780, under command of Capt. Benjamin Warren ; also, list of men raised for the 6 months service and returned by Brig. Gen. Paterson as having passed muster in a return dated Camp Totoway, Oct. 25, 1780; also, pay roll for 6 months men raised by the town of Harwich for service in the Continental Army during 1780; marched July 8, 1780; discharged Dec. 13, 1780; service, 5 mos. 20 days.

Eldridg, Obadiah, Harwich. Private, Capt. Abijah Bangs's co. Col. Nathaniel Freeman's regt.; service from Oct. 1, 1777, to Nov. 1, 1777, 31 days, on a secret expedition to Rhode Island.

**Eldredge, Ebenezer**. Private, Capt. Thomas Hamilton's co.; enlisted July 12, 1775; service to Dec. 31, 1775, 6 mos. 5 days; company stationed in Barnstable Co. for defence of seacoast; roll sworn to in Middlesex Co.; also, Capt. Elijah Smalley's CO., Maj. Zenas Winslow's regt.; service, 6 days, on an alarm at Bedford and Falmouth in Sept., 1778. Burial Hawks Nest.

**Eldredge, Hezekiah**. Private, Capt. Thomas Hamilton's co.; enlisted July 12, 1775; service to Dec. 31, 1775, 6 mos. 5 days; company stationed in Barnstable Co. for defence of seacoast. Roll sworn to in Middlesex Co.

**Eldredge, Isaac**. Private, Capt. Elijah Smalley's co., Maj. Zenas Winslow's regt.; service, 2 days, on an alarm at Bedford and Falmouth in Sept., 1778 ; also, Capt. Benjamin Godfrey's co., Maj. Zenath Winslow's regt. ; service, 5 days, on alarms at Bedford and Falmouth in Sept., 1778; roll sworn to in Barnstable.

**Eldredge, Judah**. Corporal, Capt. Elijah Smalley's co., Maj. Zenas Winslow's regt.; service, 3 days, on an alarm at Bedford and Falmouth in Sept., 1778.

**Eldredge, Reuben, Jr.** Private, Capt. Thomas Hamilton's co.; enlisted July 12, 1775; service to Dec. 31, 1775, 6 mos. 5 days; company stationed in Barnstable Co. for defence of seacoast; roll sworn to in Middlesex Co. ; also, Capt. Elijah Smalley's co., Maj. Zenas Winslow's regt.; service, 7 days, on an alarm at Bedford and Falmouth in Sept., 1778.

**Eldredge, Samuel**. Private, Capt. Elijah Smalley's co., Maj. Zenas Winslow's regt. ; service, 6 days, on an alarm at Bedford and Falmouth in Sept., 1778.

## Revolutionary War Memorial for the Town of Harwich, Massachusetts

**Eldredg (Eldredge), Thomas.** 1st Lieutenant, Capt. Elijah Small's 13th (4th Harwich) co., 2d Barnstable Co. regt. of Mass. militia; list of officers chosen by the several companies in said regiment, as returned by Joseph Doane; ordered in Council April 20, 1776, that said officers be commissioned.

**Eldrig (Eldredge), William,** Harwich. Private, Capt. Samuel King's co. Col. Josiah Whitney's regt.; service from Aug. 1, 1776, to Nov. 1, 1776, 3 mos.; roll dated Camp at Hull; also, same co. and regt.; service from Nov. 1, 1776, to Dec. 1, 1776, 1 mo. 4 days, travel included.

Ellis. [This name also appears under the form of Ales, Alice, Alles, Alice, Allis, Blish, Eells, Eels, Eles, Eles, Elies, Ellis, Eliss, Ellas, Elles, Ellice, Ellies, Ellise, Elliss, Ells, Ellys, Ely.]

**Ellis, Abraham,** Harwich. Capt. Samuel King's co. ; company order for wages dated Hull, June 20, 1776 ; also, petition dated Camp at Hull, Sept. 17, 1776, signed by said Ellis and others, asking for increase and payment of wages; also. Private, Capt. Samuel King's co. Col. Josiah Whitney's regt.; service from May 23, 1776, 4 days preceding march, to Dec. 1, 1776, 6 mos. 12 days, travel included; rolls dated Camp at Hull ; also, Capt. Abijah Bangs's co., Col. Nathaniel Freeman's regt.; service from Oct. 1, 1777, to Nov. 1, 1777, 31 days, on a secret expedition to Rhode Island; also, Capt. Thomas Nickerson's co., Maj. Zenas Winslow's regt. ; service, 4 days, on an alarm at Bedford and Falmouth in Sept., 1778.

**Ellis, Atkins,** Harwich. List of men raised to serve in the Continental Army from 2d Barnstable Co. regt., as returned by Capt. Abijah Bangs and Maj. Zenas Winslow, sworn to in Barnstable Co., Feb. 24, 1778 ; residence, Harwich ; engaged for town of Harwich; joined Capt. G. Webb's co.. Col. Shephard's regt.; term to expire in 1780 ; also, list of men mustered by Joseph Otis, Muster Master for Barnstable Co., dated April 30, 1777 ; Capt. Benson's co.. Col. Putnam's regt. mustered April 15, 1777; term, during war; reported received State and Continental bounties; also, Corporal, Capt. Joshua Benson's co. Col. Rufus Putnam's regt.; Continental Army pay accounts for service from Feb. 10, 1777, to Dec. 31, 1779; also, Capt. Benson's co.. Col. Putnam's (4th) regt.; muster return dated Albany, Feb. -, 1778 ; also, list of deserters from Col. Putnam's (5th) regt. dated Nov. 20, 1780; age, 27yrs.; stature, 5 ft. 6 in.; complexion, light; hair, brown; residence, Harwich; term, during war; reported deserted March, 1780; also, affidavit sworn to in Kennebec Co., March 4, 1820, signed by said Ellis, stating that he was 68 yrs. of age, a resident of Industry, Maine, that he enlisted in Feb., 1777, at Harwich, as a Corporal in Capt. Joshua Benson's co.. Col. Rufus Putnam's regt. to serve during the war; that he served until Dec. -, 1779, when he was furloughed for 60 days; and that he had never received the delayed wages and interest due him; affidavit endorsed " the account on books imperfect and he left service irregularly, being furloughed and not returned;" Ebenezer Billings of Boston, given power of attorney to receive money for said Ellis.

**Ellis, Ebenezer,** Harwich. Capt. Samuel King's co.; company order for wages dated Hull, June 20, 1776 ; also, Private, Capt. Samuel King's co., Col. Josiah Whitney's regt. ; service from May 23, 1776, 4 days prior to marching, to Dec. 1, 1776, 6 mos. 12 days, travel included; rolls dated Camp at Hull; also, Capt. Abijah Bangs's co.. Col. Nathaniel Freeman's regt.; service from Oct. 1, 1777, to Nov. 1, 1777, 31 days, on a secret expedition to Rhode Island.

**Ellis, Isaac.** Corporal, Capt. Elijah Smalley's co., Maj. Zenas Winslow's regt.; service, 3 days, on an alarm at Bedford and Falmouth in Sept., 1778.

**Ellis, Joseph.** Private, Capt. Benjamin Godfrey's co., Col. John Cushing's regt.; service from Sept. 30, 1776, 1 mo. 24 days, at Rhode Island. Roll dated Newport and sworn to in Barnstable Co

**Ellis, Josiah,** Harwich. Capt. Samuel King's co. ; company order for wages dated Hull, June 20, 1776; also, petition dated Camp at Hull, Sept. 17, 1776, signed by said Ellis and others, asking for increase and payment of wages ; also, petition dated Hull, Oct. 30, 1776, signed by said Ellis and others, asking for compensation for having subsisted themselves for 7 days, in consequence of having been delayed in joining regiment at Hull by stress of weather, etc., they having been ordered by resolve of June 8, 1776, to proceed on board the sloop " Betsy " to Falmouth, Casco

## Revolutionary War Memorial for the Town of Harwich, Massachusetts

Bay, as guards over cannon, etc., forwarded to that place ; petition certified by Col. Josiah Whitney; also. Private, Capt. Samuel King's co. Col. Josiah "Whitney's regt. ; service from May 23, 1776, 4 days prior to marching, to Dec. 1, 1776, 6 mos. 12 days; rolls dated Hull; also, list of men raised to serve in the Continental Army from 2d Barnstable Co. regt., as returned by Capt. Abijah Bangs and Maj. Zenas Winslow, dated Feb. 24, 1778 ; residence, Harwich engaged for town of Harwich ; joined Capt. G. Weeb's (Webb's) co.. Col. Shephard's regt. ; term, 3 years, to expire in 1780; reported mustered March 11, 1777, by Joseph Otis, Muster Master for Barnstable Co. ; also. Private, Capt. George Webb's CO., Col. William Sheppard's regt. ; Continental Army pay accounts for service from March 1, 1777, to April 13, 1777 ; reported deceased.

**Ellis, William**, Harwich. Private, Capt. Seth Clark's co. ; service from July 1, 1775, to Dec. 31, 1775, 6 mos. 1 day, in defence of seacoast; also, Corporal, Capt. Samuel King's co. ; company order for wages dated Hull, June 20, 1776; also, petition dated Camp at Hull, Sept. 17, 1776, signed by said Ellis and others, asking for increase and payment of wages ; also, Capt. Samuel King's co., Col. Josiah "Whitney's regt.; enlisted May 23, 1776; service to Dec. 1, 1776, 6 mos. 12 days, travel included ; rolls dated Camp at Hull ; also. Sergeant, Capt. Abijah Bangs's co.. Col. Nathaniel Freeman's regt.; service from Oct. 1, 1777, to Nov. 1, 1777, 31 days, on a secret expedition to Rhode Island.

**Feathagil, Richard**, Harwich. Private, Capt. Isaiah Higgins's co. Col. Thomas Marshall's regt.; service from Nov. 1, 1776, to date of discharge, Dec. 1, 1776, 1 mo.

Feathergil, Richard. Private, Capt. Isaiah Higgins's co., Col. Marshal's (Marshall's) regt. ; abstract for advance pay for 1 month from June 6, 1776, travel allowance, etc., sworn to in Suffolk Co., June 18, 1776; Harwich reported as last place of rendezvous; company stationed at Boston June 17, 1776; also, Capt. Abijah Bangs's co., Maj. Zenas Winslow's regt.; service, 5 days, on an alarm at Bedford and Falmouth in Sept., 1778; roll endorsed " 2d Barnstable Co. regt."

Feathergill, Richard, Harwich. Private, Capt. Abijah Bangs's co., Col. Dike's regt. ; pay abstract for gun and blanket money dated Boston, Feb. 24, 1777 ; also, same co. and regt. ; service from Dec. 3, 1776, to March 1, 1777 ; also, Capt. Abijah Bangs's co., Col. Nathaniel Freeman's regt.; payroll for Oct., 1777; service, 31 days, on a secret expedition to Rhode Island ; also, Capt. Abijah Bangs's co. service, 2 days, guarding prisoners from the British ship "Somerset "at Harwich and from thence to Yarmouth ; roll dated Harwich, Nov. 7, 1778.

Fethergell, Richard, Harwich. Private, Capt. Isaiah Higginson's co. Col. Thomas Marshall's regt.; enlisted June 6, 1776; service to Aug. 1, 1776, 1 mo. 26 days.

**Finney, Seth**, Harwich. Private, Capt. Abijah Bangs's co. Col. Nathaniel Freeman's regt.; service from Oct. 1, 1777, to Nov. 1, 1777, 31 days, on a secret expedition to Rhode Island.

**Fling, James**, Harwich. Private, Capt. Seth Clark's (Seacoast) co.; enlisted July 1, 1775; discharged Dec. 31, 1775 ; service, 6 mos. 10 days ; roll sworn to in Barnstable Co. ; also, list of men raised to serve in the Continental Army from 2d Barnstable Co. regt., as returned by Maj. Zenas Winslow and Capt. Abijah Bangs, sworn to Feb. 24, 1778; residence, Harwich; engaged for town of Harwich;; joined Capt. G. Webb's co., Col. Shephard's regt.; term, 3 years, to expire in 1780; also, list of men mustered by Joseph Otis, Muster Master for Barnstable Co., dated April 14, 1777; Capt. Winship's co., Col. Putnam's regt.; mustered April 3, 1777; reported received State and Continental bounties; also, Private, Capt. Gardner's co., Col. Putnam's (5th) regt.; Continental Army pay accounts for service from Jan. 6, 1777, to Dec. 31, 1779; also, Capt. Benjamin Gates's co.. Col. Rufus Putnam's regt. ; return made by Lieut. Ivory Holland, dated Albany, Feb. 9, 1778 ; mustered by Capt. Newhall ; also, (late) Capt. Gates's co., 4th Mass. regt. commanded by Col. Rufus Putnam; return for gratuity approved April 22, 1779 ; also. Colonel's co., Col. Putnam's regt. ; Continental Army pay accounts for service from Jan. 1, 1780, to April 30, 1780 ; reported discharged April 30, 1780.

## Revolutionary War Memorial for the Town of Harwich, Massachusetts

**Forster, Chillingworth.** Private, Capt. Benjamin Berry's co. of Harwich militia, Maj. Zenas Winslow's regt.; service, 3 days, on an alarm at Bedford and Falmouth Sept. 7, 1778.

**Foster, David.** 1st Lieutenant, Capt. Abijah Bangs's 8th (3d Harwich) co., 2d Barnstable Co. regt. of Mass. militia ; list of officers chosen in said regiment, as returned by Joseph Doane ; ordered in Council April 20, 1776, that said officers be commissioned ; reported commissioned April 20, 1776 ; also. Lieutenant, Capt. Abijah Bangs's co., Maj. Zenas Winslow's (2d Barnstable Co.) regt.; service, 7 days, on the alarms at Bedford and Falmouth in Sept., 1778; also, Capt. Abijah Bangs's co. ; service, 2 days, guarding prisoners from the British ship "Somerset," at Harwich, and thence to Yarmouth; roll dated Harwich, Nov. 9, 1778; also, same co. ; service, 2 days, guarding prisoners from the British ship "Somerset," at Harwich, and thence to Barnstable; roll dated Harwich, Nov. 9, 1778.

**Foster, Elisha,** Harwich. Private, Capt. Abijah Bangs's co., Col. Nathaniel Free- man's regt. ; service from Oct. 1, 1777, to Nov. 1, 1777, 31 days, on a secret expedition to Rhode Island.

**Foster, James.** Private, Capt. Abijah Bangs's co., Col. Dike's regt.; pay roll for gun and blanket money dated Boston, Feb. 24, 1777; also, same co. and regt; service from Dec. 13, 1776, to March 1, 1777; credited to town of Harwich; also, Capt. Bangs's co.; service, 2 days, guarding prisoners from the British ship "Somerset" at Harwich, and from thence to Yarmouth; roll dated Harwich, Nov. 9, 1778.

**Foster, Nathaniel.** Private, Capt. Abijah Bangs's co., Maj. Zenas Winslow's (2d Barnstable Co.) regt.; service, 5 days, on alarms at Bedford and Falmouth in Sept., 1778 ; also, Capt. Abijah Bangs's co. ; service, 2 days, guarding prisoners from the British ship "Somerset" at Harwich, and thence to Yarmouth; roll dated Harwich, Nov. 9, 1778.

### Volume 6: FRA-GYP

**Freeman, Barnabas.** Private, Capt. Benjamin Berry's (Harwich) co., Maj. Zenas Winslow's regt.; service, 4 days, on an alarm at Bedford and Falmouth Sept. 7, 1778. Roll sworn to in Barnstable Co.

**Freeman, Benjamin.** Private, Capt. Seth Clark's co. ; service, 6 mos. 10 days, in de- fence of seacoast; company served from July 1, 1775, to Dec. 31, 1775; roll sworn to in Barnstable Co.; also, Capt. Benjamin Berry's (Harwich) co., Maj. Zenas Winslow's regt. ; service, 6 days, on an alarm at Bedford and Falmouth Sept. 7, 1778 ; roll sworn to in Barnstable Co.

**Freeman, Elkanah.** Corporal, Capt. Benjamin Berry's (Harwich) co., Maj. Zenas Winslow's regt.; service, 7 days, on an alarm at Bedford and Falmouth Sept. 7, 1778. Roll sworn to in Barnstable Co.

**Freeman, Hatssald.** Private, Capt. Benjamin Berry's (Harwich) co., Maj. Zenas Winslow's regt.; service, 6 days, on an alarm at Bedford and Falmouth Sept. 7, 1778. Roll sworn to in Barnstable Co.

**Freeman, John.** Private, Capt. Benjamin Berry's (Harwich) co., Maj. Zenas Winslow's regt.; service, 6 days, on an alarm at Bedford and Falmouth Sept. 7, 1778. Roll sworn to in Barnstable Co.

**Freeman, Nathaniel.** 1st Lieutenant, Capt. Benjamin Berry's 3d (1st Harwich) co., 2d Barnstable Co. regt. of Mass. militia ; list of officers chosen in said regiment, as returned by Joseph Doane; ordered in Council April 20, 1776, that said officers be commissioned; reported commissioned April 20, 1776; also. Captain, Lieut. Col. Enoch Hallet's (Barnstable Co.) regt.; appointed July 15, 1780; discharged Oct. 31, 1780; service, 3 mos. 21 days, travel included; company raised to reinforce Continental Army for 3 months.

Freeman, Nathaniel. Petition signed by Samuel Doggett and others, in behalf of themselves and others, of Boston and Harwich, asking that said Freeman be commissioned as commander of the sloop "Wolf" (privateer) ; ordered in Council Sept. 4, 1776, that a commission be issued; also, petition dated Boston, May 14, 1779, signed by Nathan Stone, in behalf of himself and William Foster, of Boston, asking that said

## Revolutionary War Memorial for the Town of Harwich, Massachusetts

Freeman be commissioned as commander of the brigantine "Black Joke " (privateer) ; ordered in Council May 14, 1779, that a commission be issued.

**Freeman, Seth.** Private, Capt. Benjamin Berry's (Harwich) co., Maj. Zenas Winslow's regt.; service, 6 days, on an alarm at Bedford and Falmouth Sept. 7, 1778; roll sworn to in Barnstable Co. ; also, Capt. Simeon Fish's co.. Col. Freeman's regt.; engaged Sept. 11, 1779; discharged Sept. 12, 1779; service, 2 days, on an alarm at Falmouth; company ordered out by Brig. Otis; roll dated Sandwich.

**Freeman, Thomas.** Private, Capt. Abijah Bangs's co., Maj. Zenas Winslow's (2d Barnstable Co.) regt.; service, 5 days, on alarms at Bedford and Falmouth in Sept., 1778.

**Freeman, Watson,** Harwich. List of men raised to serve in the Continental Army from 2d Barnstable Co. regt., as returned by Capt. Abijah Bangs and Maj. Zenas Winslow, dated Feb. 24, 1778; residence, Harwich; engaged for town of Harwich; joined Capt. George Webb's co.. Col. Sheppard's regt.; term, 3 years, to expire in 1780; reported mustered April 14, 1777, by Joseph Otis, Muster Master for Barnstable Co.; also. Private, Capt. George Webb's co., Col. William Sheppard's regt. ; Continental Army pay accounts for service from April 7, 1777, to Dec. 31, 1779; also, Capt. Webb's co., Col. Shepard's (3d) regt.; muster rolls for Oct., 1778, March and April, 1779, dated Camp at Providence; enlisted April 7, 1777; enlistment, during war; also, Capt. David Holebrook's co.. Col. Shepard's (4th) regt.; Continental Army pay' accounts for service from Jan. 1, 1780, to April 7, 1780; reported discharged April 7, 1780.

**Gage, Anthony,** Harwich. Private, Capt. Elihu Gifford's co., Col. William Turner's regt.; enlisted July 26, 1781; discharged Nov. 27, 1781; service at Rhode Island; regiment raised in Bristol and Barnstable counties to serve for 5 months; roll sworn to at Boston; also, certificate dated Dartmouth, Feb. 16, 1785, signed by Elihu Gifford, stating that said Gage and Anthony Baker, both of Harwich, Barnstable Co., were in his company. Col. William Turner's regt., in the 5 mos. service at Rhode Island in 1781.

**Gage, Edward,** Harwich (also given Yarmouth). Private, Capt. Samuel King's co. Col. Josiah Whitney's regt.; service from May 23, 1776, 4 days prior to marching, to Nov. 1, 1776, 5 mos. 8 days ; rolls dated Camp at Hull ; also, Capt. King's Co., company order for wages dated Hull, June 20, 1776 ; also, petition, dated Camp at Hull, Sept. 17, 1776, signed by said Gage and others, asking for increase and payment of wages ; also, Private, Capt. Samuel King's co.. Col. Josiah Whitney's regt.; service from Nov. 1, 1776, to Dec. 1, 1776, 1 mo. 4 days, travel included; also, Capt. Micah Hamlen's co. Col. Jonathan Reed's (1st) regt. of guards; service between April 20, 1778, and July 6, 1778, 2 mos. 15 days, at Cambridge; enlistment, 3 months from April 2, 1778 ; also, same co. and regt. ; muster roll dated Cambridge, May 9, 1778; reported sick in hospital; also, same co. and regt.; muster roll for May, 1778, dated Cambridge; reported sick in barracks; also, Capt. John Nickerson's co.. Col. Nathaniel Freeman's regt.; service, 7 days, on an alarm at Dartmouth and Falmouth in Sept., 1778.

**Gage, Elkanah,** Harwich. Private, Capt. John Grannis's co. commanded by Lieut. James Blossom; enlisted Sept. 1, 1776; service to Nov. 21, 1776, 2 mos. 21 days, in defence of seacoast; company stationed at Elizabeth Islands; also, Capt. Benjamin Godfrey's co.. Col. Josiah Whitney's regt. ; arrived at destination May 10, 1777 ; discharged July 10, 1777 ; service, 2 mos. 11 days, travel included, at Rhode Island ; enlistment, 2 months ; roll dated Boston Neck, South Kingston.

**Gage, Isaac.** Private, Capt. Seth Clark's co.; enlisted July 1, 1775; discharged Dec. 31, 1775; service, 6 mos. 9 days, in defence of seacoast. Roll sworn to in Barnstable.

**Gage, James.** Private, Capt. Thomas Nickerson's co., Maj. Zenas Winslow's regt.; service, 1 day, on at alarm at Bedford and Falmouth in Sept., 1778.

**Gage, John.** 1st Lieutenant, Capt. Thomas Nickerson's 7th (2d Harwich) co., 2d Barnstable Co. regt. of Mass. militia; list of officers returned by Joseph Doane; ordered in council April 20, 1776, that said officers be commissioned;

## Revolutionary War Memorial for the Town of Harwich, Massachusetts

reported commissioned April 20, 1776; also, Capt. Thomas Nickerson's co., Maj. Zenas Winslow's regt.; service, 9 days, on an alarm at Bedford and Falmouth in Sept., 1778.

**Gage, Thomas**, Harwich. Private, Capt. Seth Clark's co.; enlisted July 1, 1775; discharged Dec. 31, 1775; service, 6 mos. 8 days, in defence of seacoast; roll sworn to in Barnstable Co.; also, Capt. John Grannis's co.; enlisted June 1, 1776; service to Aug. 31, 1776, 3 mos. ; company stationed at Elizabeth Islands for defense of seacoast; roll dated Tarpaulin Cove; also, Capt. Grannis's co. commanded by Lieut. James Blossom ; service from Sept. 1, 1776, to Nov. 21, 1776, 2 mos. 21 days, in defense of seacoast; company stationed at Elizabeth Islands; also, Capt. Abijah Bangs's co.. Col. Nathaniel Freeman's regt.; pay roll for Oct., 1777; service, 31 days, on a secret expedition to Rhode Island.

**Gage, William**. Private, Capt. Elijah Smalley's co., Maj. Zenas Winslow's regt.; service, 4 days, on an alarm at Bedford and Falmouth in Sept., 1778.

**Gage, William, Jr.** Private, Capt. Seth Clark's co. ; enlisted July 1, 1775 ; discharged Dec. 31, 1775; service, 6 mos. 10 days, in defence of seacoast. Roll sworn to in Barnstable

**Gage, Zebulon**. Sergeant, Capt. Benjamin Godfrey's co. Col. John Cushing's regt.; service from Sept. 30, 1776, 1 mo. 24 days, at Rhode Island. Roll dated Newport and sworn to in Barnstable Co.

**Godfree, Benjamin**. Captain of a company raised in Chatham, Harwich, Truro, and Eastham ; list dated Barnstable, Oct. 4, 1776, of officers and men raised from Barnstable Co. brigade to serve at Rhode Island, as returned by Brig. Joseph Otis to Maj. Gen. Warren; also, return dated Barnstable, May 19, 1777, signed by Joseph Otis, stating that 105 men had been detached from his brigade and had marched, with the exception of 18, the proportion of the town of Barnstable; said Godfree appears as Captain of a company made up of 50 of said men.

**Godfrey, Joseph**, Harwich. Private, Capt. Joseph Griffith's co., Col. John Jacobs's regt.; enlisted June 20, 1778 ; service, 6 mos. 15 days, travel included ; enlistment to expire Jan. 1, 1779

**Gould, John**. Private, Capt. Abijah Bangs's co., Maj. Zenas Winslow's (2d Barnstable Co.) regt. ; service, 5 days, on alarms at Bedford and Falmouth in Sept., 1778 ; also, Capt. Abijah Bangs's co. ; service, 2 days, guarding prisoners from the British ship "Somerset "at Harwich and from thence to Yarmouth; roll dated Harwich, Nov. 7, 1778.

**Gray, Anthony**. Private, Capt. Benjamin Berry's (Harwich) co., Maj. Zenas Winslow's regt.; service, 5 days, on an alarm at Bedford and Falmouth, Sept. 7, 1778.

**Gray, John**, Harwich. Private, Capt. Abijah Bangs's co. Col. Nathaniel Freeman's regt. ; pay roll for Oct., 1777, dated Harwich ; service, 31 days, on a secret expedition to Rhode Island; also, Capt. Benjamin Berry's (Harwich) co., Maj. Zenas Winslow's regt. ; service, 7 days, on an alarm at Bedford and Falmouth Sept. 7, 1778.

**Gray, Joshua**. Private, Capt. Lot Crowell's co. Col. Nathaniel Freeman's regt.; service, 13 days, on an alarm at Dartmouth and Falmouth in Sept., 1778; also, Capt. Abijah Bangs's co. ; service, 2 days, guarding prisoners from the British ship " Somerset " at Harwich and thence to Barnstable ; roll dated Nov. 9, 1778.

**Gray, Lot**. Private, Capt. Benjamin Berry's (Harwich) co., Maj. Zenas Winslow's regt.; service, 6 days, on an alarm at Bedford and Falmouth Sept. 7, 1778.

**Gray, Lot, Jr.** Private, Capt. Abijah Bangs's co.; service, 2 days, guarding prisoners from the British ship "Somerset" at Harwich and thence to Yarmouth. Roll dated Nov. 9, 1778.

**Gray, Samuel**. Private, Capt. Lot Crowell's co. Col. Nathaniel Freeman's regt. ; service, 13 days, on an alarm at Dartmouth and Falmouth in Sept., 1778 ; also, Capt. Abijah Bangs's co. ; service, 2 days, guarding prisoners from the British ship " Somerset " at Harwich and thence to Yarmouth ; roll dated Nov. 9, 1778 ; also, Capt. Nathaniel Freeman's co., Lieut. Col. Enoch Hallet's (Barnstable Co.) regt. ; enlisted Aug. 16, 1780; discharged Oct. 31, 1780; service, 2 mos. 20 days, travel included ; company raised to reinforce Continental Army for 3 months.



## Revolutionary War Memorial for the Town of Harwich, Massachusetts

**Griffen (Griffith?), Barnabas**, Harwich. Sergeant, Capt. Abijah Bangs's co., Col. Nathaniel Freeman's regt.; pay roll for Oct., 1777; service, 31 days; company marched on a secret expedition to Rhode Island.

Griffin, Barnabas. Private, Capt. Benjamin Berry's (Harwich) co., Maj. Zenas Winslow's regt.; service, 2 days, on an alarm at Bedford and Falmouth Sept. 7, 1778; roll sworn to in Barnstable Co. ; also, Sergeant, Capt. Nathaniel Freeman's CO., Lieut. Col. Enoch Hallet's (Barnstable Co.) regt.; engaged Aug. 16, 1780; discharged Oct. 31, 1780 ; service, 2 mos. 20 days, travel included ; company raised to reinforce Continental Army for 3 months. Burial Old Burial Grounds Brewster

**Griffin, Stephen**. Private, Capt. Benjamin Berry's (Harwich) co., Maj. Zenas Winslow's regt.; service, 7 days, on an alarm at Bedford and Falmouth Sept. 7, 1778.

### Volume 7: HAA-HIX

**Hall, Benjamin**. Corporal, Capt. Seth Clark's co. ; enlisted July 1, 1775; discharged Dec. 31, 1775; service, 6 mos. 4 days, in defence of seacoast; roll sworn to in Barnstable Co. ; also, Capt. Thomas Nickerson's co., Maj. Zenas Winslow's regt. ; service, 6 days, on an alarm at Bedford and Falmouth in Sept., 1778 ; roll sworn to in Barnstable

**Hall, Nathaniel**, Harwich. Official record of a ballot by the House of Representatives, dated Jan. 23, 1776, for officers to command the 6 regiments raised to serve before Boston until April 1, 1776; said Hall chosen Surgeon's Mate, Col. Simon Gary's regt., raised in Plymouth and Barnstable counties; appointment concurred in by Council Jan. 23, 1776.

**Hamlen, Benjamin**, Harwich. Private, Capt. David Holebrook's co., Col. William Shepard's (4th) regt.; Continental Army pay accounts for service from Jan. 1, 1780, to March 1, 1780; residence, Harwich; reported transferred to corps of invalids, but said Hamlen later produced proof that he had been discharged March 1, 1780; also, same co. and regt.; return made up from Jan. 1, 1780, to Dec. 31, 1780; enlisted Maj 15, 1777; enlistment, during war; reported transferred to corps of invalids March 1, 1780.

**Higgins, Solomon**, Harwich. Private, Capt. Benjamin Godfrey's co., Col. Josiah Whitney's regt. ; arrived at destination May 10, 1777; discharged July 10, 1777; service, 2 mos. 11 days, at Rhode Island, travel (11 days) included; 100 miles reported as distance from Harwich to place of destination ; enlistment, 2 months. Roll dated Boston Neck, South Kingston.

**Higgins, Zedekiah**, Harwich. Private, Capt. Benjamin Godfrey's co.. Col. Josiah Whitney's regt.; arrived at destination May 10, 1777; discharged July 10, 1777; service, 2 mos. 11 days, at Rhode Island, travel (11 days) included; 100 miles reported as distance from Harwich to place of destination; enlistment, 2 months. Roll dated Boston Neck, South Kingston.

**Hinckley, Philip**. List of men mustered by Joseph Otis, Muster Master for Barnstable Co., dated Barnstable, March 14, 1777; Capt. Webb's co., Col. Sheppard's regt.; engaged for town of Harwich; mustered March 11, 1777; term, during war.

Hinkly, Philip, Harwich. Corporal, Capt. David Holbrook's co., Col. William Shepard's (4th) regt.; Continental Army pay accounts for service from Jan. 1, 1780, to Dec. 31, 1780; also, Capt. Webb's co. Col. Shepard's regt.; return for gratuity, dated Highlands, Feb. 2<sup>d</sup>, 1780; also, Capt. Holbrook's co. Col. Shepard's regt.; return made up for the year 1780; residence, Harwich; enlisted March 1, 1777; enlistment, during war.

**Hinkley, Seth**, Harwich. List of men raised to serve in the Continental Army from 2d Barnstable Co. regt., as returned by Maj. Zenas Winslow and Capt. Abijah Bangs; residence, Harwich; engaged for town of Harwich; joined Capt. G. Webb's CO., Col. Sheppard's regt.; term to expire in 1780; also, Fifer, Capt. Simon Larned's co., Col.

## Revolutionary War Memorial for the Town of Harwich, Massachusetts

William Sheppard's regt.; Continental Army pay accounts for service from Jan. 1, 1777, to Dec. 31, 1779; also, Capt. Job Alvord's CO., Col. William Shepard's (3d) regt. ; return of men who were in service Aug. 15, 1777; also, Private, same co. and regt. ; return dated Jan. 31, 1778; mustered by State and Continental Muster Masters ; also, Fifer, same co. and regt. ; muster rolls for Oct. and Nov., 1778, dated Providence; enlistment, 3 years; also, Capt. Simon Larned's co.. Col. Shepard's regt. ; muster roll for March and April, 1779, dated Providence ; also, descriptive list of men belonging to Col. William Shepard's (4th) regt. who re-enlisted subsequent to Sept. 30, 1779, dated Bud's Highlands; age, 23 yrs. ; stature, 5 ft. 7 in. ; complexion, light; hair, light; residence, Harwich; also, Private and Fife Major, Capt. Isaac Pope's co., Col. Shepard's regt.; Continental Army pay accounts for service from Jan. 1, 1780, to Dec. 31, 1780; reported as serving 2 mos. as Private, 10 mos. as Fife Major; also, Fifer, same co. and regt. ; return made up for the year 1780, dated Hutts, near West Point; appointed Fife Major Feb. 27, 1780; also, Fife Major, same co. and regt.; muster rolls for May and July, 1781, sworn to in Camp at Phillipsborough.

### Volume 8: HME-JYP

**Hopkins, Ebenezer.** Private, Capt. Elijah Smalley's co., Maj. Zenas Winslow's regt.; service, 4 days, on an alarm at Bedford and Falmouth in Sept., 1778. [See Edward Hopkins.]

**Hopkins, Elkanah.** Private, Capt. Benjamin Berry's (Harwich) co., Maj. Zenas "Winslow's regt.; service, 3 days, on an alarm at Bedford and Falmouth, Sept. 7, 1778; roll sworn to in Barnstable Co.; also, Sergeant; account dated Harwich, Nov. 9, 1778, rendered by Capt. Abijah Bangs, for amounts due men who guarded prisoners from the [British] ship "Somerset" at Harwich, and from thence to Barnstable, by order of Maj. Gideon Freeman; service, 2 days.

**Hopkins, Giles, Harwich [probably].** Private, Capt. Joseph Griffith's co., Col. John Jacobs's regt.; enlisted June 16, 1778; service, 2 mos. 17 days; enlistment to expire Jan. 1, 1779; reported died Sept. 2, 1778.

**Hopkins, Jonathan.** Private, Capt. Joseph Smith's co. ; service from May 31, 1776, to Nov. 22, 1776, 5 mos. 22 da3'S ; company stationed at Truro for defence of sea- coast; also, Corporal, Capt. Joshua Higgins's co., Maj. Zenas Winslow's regt.; service from Sept. 6, 1778, to Sept. 13, 1778, 6 days, on alarms at Bedford and Falmouth; also, Private, Capt. Abijah Bangs's co., Maj. Zenas Winslow's (2d Barnstable Co.) regt.; service, 5 days, on alarms at Bedford and Falmouth in Sept., 1778; also, account dated [Harwich, Nov. 7, 1778], rendered by Capt. Abijah Bangs for amounts due men who guarded prisoners from the [British] ship "Somerset " at Harwich, and from thence to Yarmouth ; service, 2 days.

**Hopkins, Moses.** Private, Capt. Elijah Smalley's co., Maj. Zenas Winslow's regt.; service, 4 days, on an alarm at Bedford and Falmouth in Sept., 1778.

Hopkins, Moses. Private, Capt. Abijah Bangs's co., Maj. Zenas Winslow's (2d Barnstable Co.) regt.; service, 5 days, on alarms at Bedford and Falmouth in Sept., 1778.

**Hopkins, Prince.** Private, Capt. Abijah Bangs's co., Maj. Zenas Winslow's (2d Barnstable Co.) regt.; service, 7 days, on alarms at Bedford and Falmouth in Sept., 1778; also, account dated [Harwich, Nov. 7, 1778], rendered by Capt. Abijah Bangs, for amounts due men who guarded prisoners from the [British] ship "Somerset" at Harwich, and from thence to Yarmouth; service, 2 days.

**Hopkins, Roland.** Private, Capt. Seth Clark's co. ; enlisted July 1, 1775; discharged Dec. 31, 1775; service, 6 mos. 10 days, in defence of seacoast. Roll sworn to in Barnstable Co.

**Hopkins, Samuel.** Private, Capt. Abijah Bangs's co., Col. Dike's regt.; pay roll for gun and blanket money, dated Boston, Feb. 24, 1777; also, Corporal, same co. and regt.; muster roll for Dec, 1776-Feb., 1777; enlisted Dec. 13, 1776; credited to town of Harwich; regiment raised to serve until March 1, 1777.

## Revolutionary War Memorial for the Town of Harwich, Massachusetts

**Hopkins, Stephen.** Private, Capt. Abijah Bangs's co., Maj. Zenas Winslow's (2d Barnstable Co.) regt.; service, 5 days, on alarms at Bedford and Falmouth in Sept., 1778; also, account dated Harwich, Nov. 9, 1778, rendered by Capt. Abijah Bangs, of amounts due men who guarded prisoners from the [British] ship "Somerset" at Harwich, and from thence to Barnstable, by order of Maj. Gideon Freeman; service, 2 days.

**Howell, James,** Harwich. List of men belonging to Capt. Abijah Bangs's co. raised from various towns in Barnstable Co., dated Dorchester, Sept. 4, 1776; also, Corporal, Capt. Abijah Bangs's co. Col. Dike's regt.; pay roll for travel allowance from home and return, etc., dated Boston, Nov. 26, 1776; said Howell credited with 4 days allowance; mileage to and from camp (184 miles) also allowed; also. Private, Capt. Abijah Bangs's co. Col. Dike's regt.; abstract for gun and blanket money, dated Boston, Feb. 24, 1777; also, same co. and regt.; muster roll for Dec, 1776-Feb., 1777; enlisted Dec. 1, 1776; regiment raised to serve until March 1, 1777.

**Howell, Peter.** Private, Capt. Abijah Bangs's co. Col. Dike's regt.; abstract for gun and blanket money, dated Boston. Feb. 24, 1777; also, same co. and regt.; muster roll for Dec, 1776-Feb., 1777; enlisted Dec. 13, 1776; credited to town of Harwich; regiment raised to serve until March 1, 1777; also, account dated [Harwich, Nov. 7, 1778], rendered by Capt. Abijah Bangs, of amounts due men who guarded prisoners from the [British] ship "Somerset" at Harwich, and from thence to Yarmouth; service, 2 days.

**Irish, Jon'n.** Private, Capt. Abijah Bangs's co., Col. Dike's regt.; muster roll for Dec, 1776-Feb., 1777; enlisted Dec. 13, 1776; credited to town of Harwich; regiment raised to serve until March 1, 1777.

**Jolley, Thomas,** Harwich. List of men raised to serve in the Continental Army from 2d Barnstable Co. regt., as returned by Capt. Abijah Bangs and Maj. Zenas Winslow, dated Feb. 24, 1778; residence, Harwich; engaged for town of Harwich.

**Jolly, Nathan.** Private, Capt. Abijah Bangs's co., Col. Dike's regt.; muster roll for Dec, 1776-Feb., 1777; enlisted Dec. 13, 1776; credited to town of Harwich; re-ported discharged Dec. 13, 1776; regiment raised to serve until March 1, 1777.

### Volume 9: KAB-LSU

Kelley, . [This name also appears under the form of Caley, Calley, Cellogg, Celly, Culley, Huly, Kalcy, Kaley, Kalley, Kally, Kealy, Keeay, Keeley, Keelley, Keely, Kelcy, Keley, Kellay, Kelle, Kellog, Kellogg, Kelly, Kelso, Killa, Kille, Killlee, Killley, Killy, Kilsey, KUy.]

**Kelly, Anthony.** Private, Capt. Simeon Fowler's co. Col. Jonathan Reed's (1st) regt. of guards; enlisted April 4, 1778 ; service to July 8, 1778, 3 mos. 3 days, at Cambridge; roll sworn to at Boston; also, same co. and regt. ; muster roll dated Cambridge, May 9, 1778 ; enlistment, 3 months from April 2, 1778.

**Kenyon, Benjamin,** Harwich. List of men raised to serve in the Continental Army from 2d Barnstable Co. regt., as returned by Capt. Abijah Bangs and Maj. Zenas Winslow; residence, Harwich; engaged for town of Harwich; joined Capt. G. Webb's CO., Col. Shephard's regt.; term to expire in 1780; also, Private, Capt. Joshua Benson's co.. Col. Rufus Putnam's regt.; Continental Army pay accounts for service from Feb. 10, 1777, to Dec. 31, 1779; also, Capt. Benson's co., Col. Putnam's (4th) regt.; return dated Albany, Feb. -, 1778; mustered by Brig. Otis.

Kingon, Benjamin. List of men mustered by Joseph Otis, Muster Master for Barnstable Co.; Capt. Benson's CO., Col. Putnam's regt. ; engaged for town of Harwich; mustered April 20, 1777 ; term, 3 years. [See Benjamin Kenyon.]

Kinyon, Benjamin, Harwich. Descriptive list of deserters, dated Nov. 20, 1780; Col. Rufus Putnam's (5th) regt. ; age, 30 yrs. ; stature, 5 ft. 6 in. ; complexion, darli ; hair, dark ; residence, Harwich ; engaged for town of Harwich ; term, during war ; reported deserted March -, 1780.

## Revolutionary War Memorial for the Town of Harwich, Massachusetts

**Killey, Abner.** Pay roll for 6 months men raised by the town of Harwich for service in the Continental Army during 1780; marched to camp July 14, 1780 ; discharged Dec. 13, 1780; service, 5 mos. 14 days, including travel (300 miles) home from place of destination.

Kelley, Abner, Harwich. List of men raised for the 6 months service and returned by Brig. Gen. Paterson as having passed muster in a return dated Camp Toto- way, Oct. 25, 1780.

Kelly, Abner. Descriptive list of men raised to reinforce the Continental Army for the term of 6 months, agreeable to resolve of June 5, 1780, returned as received of Justin Ely, Commissioner, by Brig. Gen. John Glover, at Springfield, Aug. 5, 1780; age, 20yrs.; stature, 5 ft. 5 in.; complexion, light; engaged for town of Harwich; arrived at Springfield Aug. 4, 1780; marched to camp Aug. 5, 1780, under command of Capt. Samuel Carr.

**King, Nathaniel.** Private, Capt. Abijah Bangs's co., Maj. Zenas Winslow's (2d Barnstable Co.) regt.; service, 7 days, on alarms at Bedford and Falmouth in Sept., 1778; also, account dated [Harwich, Nov. 7, 1778] , rendered by Capt. Abijah Bangs, for amounts due men who guarded prisoners from the [British] ship " Somerset " at Harwich, and from thence to Yarmouth ; service, 2 days.

**Laha, Isaac,** Harwich. List of men raised to serve in the Continental Army from 2d Barnstable Co. regt., as returned by Capt. Abijah Bangs and Maj. Zenas Winslow; residence, Harwich; engaged for town of Harwich; joined Capt. G. Weeb's (Webb's) CO., Col. Shephard's regt.; term to expire in 1780; also, list of men mustered by Joseph Otis, Muster Master for Barnstable Co., dated Barnstable, March 14, 1777; Capt. Webb's co. Col. Shepherd's regt.; mustered March 11, 1777; term, during war; also. Private, Capt. George Webb's co., Col. William Sheppard's regt.; Continental Army pay accounts for service from Jan. 1, 1777, to March 10, 1778; reported deceased; also, same co. and regt. ; return [year not given] ; mustered by Joseph Otis, State Muster Master, and by a Continental Muster Master.

**Laha, James.** Private, Capt. Abijah Bangs's co., Maj. Zenas Winslow's (2d Barnstable Co.) regt.; service, 5 days, on alarms at Bedford and Falmouth in Sept., 1778; also, account dated [Harwich, Nov. 7, 1778], rendered by Capt. Abijah Bangs, of amounts due men who guarded prisoners from the [British] ship "Somerset" at Harwich and thence to Yarmouth; service, 2 days.

**Lawrence, Moses.** Private, Capt. Ezekiel Knowlton's co. Col. Dike's regt.; muster roll for Dec, 1776-Feb., 1777; enlisted Dec. 31, 1776; credited to town of Harwich; regiment raised to serve until March 1, 1777.

**Lincoln, Jonathan,** Harwich. Private, Capt. Isaiah Higgins's co. Col. Thomas Marshall's regt.; service from Aug. 1, 1776, to Oct. 31, 1776, 3 mos.; also, Capt. Abijah Bangs's co., Col. Nathaniel Freeman's regt. ; pay roll for Oct., 1777, dated Harwich ; service, 31 days, on a secret expedition to Rhode Island ; also, Capt. Abijah Bangs's co., Maj. Zenas Winslow's (2d Barnstable Co.) regt.; service, 5 days, on alarms at Bedford and Falmouth in Sept., 1778.

**Lincoln, Thomas,** Harwich. List of men raised to serve in the Continental Army from 2d Barnstable Co. regt., as returned by Maj Zenas Winslow and Capt. Abijah Bangs; residence, Harwich; engaged for town of Harwich; joined Capt. G. Weeb's (Webb's) co. Col. Shephard's regt.; term, during war; also, list of men mustered by Joseph Otis, Muster Master for Barnstable Co., dated April 14, 1777; Capt. George "Webb's co., Col. Sheppard's regt.; mustered April 9, 1777; reported received State bounty; also, Private, Capt. "Webb's co., Col. "William Sheppard's regt. ; Continental Army pay accounts for service from April 1, 1777, to April 15, 1778; reported deserted; also, same co. and regt.; return [year not given] ; mustered by Joseph Otis, State Muster Master, and by a Continental Muster Master; also, Capt. Webb's co., Col. William Shepard's (4th) regt.; descriptive list of deserters made up from Jan. 1, 1777, to June 1, 1780; age, 40yrs.; stature, 5 ft. 8 in.; complexion, dark; hair, black; residence, Harwich; term, during war; deserted April 15, 1778; reported as having left regiment at Fishkill, last heard of at Casco Bay.

## Revolutionary War Memorial for the Town of Harwich, Massachusetts

Lincoln, Thomas (also given Thomas, Jr.), Harwich. List of men raised to serve in the Continental Army from 2d Barnstable Co. regt., as returned by Maj. Zenas Winslow and Capt. Abijah Bangs; residence, Harwich; engaged for town of Harwich; joined Capt. G. Webb's (Webb's) co. Col. Shephard's regt.; term to expire in 1780; also, list of men mustered by Joseph Otis, Muster Master for Barnstable Co., dated April 14, 1777; Capt. George Webb's co., Col. Sheppard's regt. ; mustered April 9, 1777 ; reported received State and Continental bounties ; also. Private, Capt. Webb's co. Col. William Sheppard's regt.; Continental Army pay accounts for service from April 1, 1777, to Dec. 31, 1779; also, same CO. and regt. ; return [year not given] ; mustered by Joseph Otis, State Muster Master, and by a Continental Muster Master; also, Capt. Webb's co.. Col. Shepard's (3d) regt.; muster roll for Oct., 1778, dated Camp at Providence; also, same co. and regt.; muster roll for March and April, 1779, dated Providence; enlisted April 1, 1777; enlistment, during war; also, Capt. Holebrook's co., Col. Shepard's regt. ; Continental Army pay accounts for service from Jan. 1, 1750, to Dec. 31, 1780; also, Capt. Webb's co., Col. Shepard's (4th) regt.; return for gratuities, dated Highlands, Feb. 24, 1780; gratuity paid said Lincoln Jan. 29, 1780; also, Capt. George Webb's (Light Infantry) co.. Col. William Shepard's (4th) regt.; muster roll for Feb.-Nov., 1781, dated Hutts 1st Brigade; also, same CO. and regt. ; muster rolls for Jan. and Feb., 1782, dated Hutts 1st Brigade and sworn to at West Point.

**Linkalon, Jonathan.** Account dated [Harwich, Nov. 7, 1778], rendered by Capt. Abijah Bangs, of amounts due men who guarded prisoners from the [British] ship " Somerset " at Harwich, and from thence to Yarmouth; service, 2 days.

**Linkhorn, Jonathan,** Harwich. Private, Capt. Benjamin Godfrey's co. Col. Josiah Whitney's regt.; arrived at destination May 10, 1777 ; discharged July 10, 1777 ; service, 2 mos. 11 days, at Rhode Island, travel (11 days) included; 100 miles reported as distance from Harwich to place of destination ; enlistment, 2 months. Roll dated Boston Neck, South Kingston.

**Linnel, Thomas.** Private, Capt. Abijah Bangs's co., Maj. Zenas Winslow's (2d Barnstable Co.) regt.; service, 3 days, on alarms at Bedford and Falmouth in Sept., 1778.

Linnel, Thomas. Private, Lieut. Samuel Knowles's co., Maj. Zenas Winslow's regt.; service from Sept. 6 to Sept. 13, 1778, 6 days, on alarms at Bedford and Falmouth; also, Private; service, 1 day, under Lieut. Samuel Knowles, guarding prisoners from the British ship " Somerset," cast ashore at Cape Cod, also guarding them while at Eastham, and marching them to the next town, by order of M.tj. Gideon Freeman; roll dated Nov. 6, 1778.

**Long, Levi.** Private, Capt. Abijah Bangs's co., Maj. Zenas Winslow's (2d Barnstable Co.) regt.; service, 5 days, on alarms at Bedford and Falmouth in Sept., 1778.

Long, Levi. Private, Capt. Elijah Smalley's co., Maj. Zenas Winslow's regt.; service, 4 days, on an alarm at Bedford and Falmouth in Sept., 1778.

### Volume 10: LUA-MOP

**Maker, Burton** (also given Burden), Harwich, also given Barnstable and Yarmouth. Private, Capt. John Russell's co.; marched July 28, 1776; service to Sept. 30, 1776, 2 mos. 2 days; company stationed at Martha's Vineyard for defence of seacoast; also, Capt. John Russell's co.; service from Sept. 30, 1776, to Nov. 22, 1776, 1 mo. 22 days ; company raised for defence of seacoast and stationed at Martin's (Martha's) Vineyard under Maj. Barachiah Bassett; also, list of men raised to serve in the Continental Army from 2d Barnstable Co. regt., as returned by Maj. Zenas Winslow and Capt. Abijah Bangs; residence, Harwich; engaged for town of Harwich ; joined Capt. G. Webb's co., Col. Shephard's regt. ; term to expire in 1780; also, list of men mustered by Joseph Otis, Muster Master for Barnstable Co., dated Barnstable, Feb. 21, 1777; Capt. James Davis's co.. Col. Gamaliel Bradford's regt.; mustered Feb. 18, 1777; term, 3 years; also, Private, 5th CO., Col. Gamaliel Bradford's regt.; Continental Army pay accounts

## Revolutionary War Memorial for the Town of Harwich, Massachusetts

for service from Feb. 15, 1777, to Dec. 31, 1779; also, Capt. John Russell's co. Col. Bradford's regt.; subsistence allowed from date of enlistment, Feb. 15, 1777, to March 21, 1777; credited with 46 days' subsistence, including allowance for 11 days (220 miles) travel on march from Boston to Bennington; also, Capt. John Lament's CO., Col. Bradford's (22nd) regt.; return [year not given]; mustered by County and Continental Muster Masters; also, same co. and regt.; return of men who were in camp on or before Aug. 15, 1777, and who had not been absent subsequently except on furlough, etc.; joined May 1, 1777; also, Capt. Haskell's co., Col. Bradford's regt.; Continental Army pay accounts for service from Jan. 1, 1780, to Dec. 31, 1780; also, descriptive list of men in Continental service; Capt. Hastings's (also given Capt. Joseph Bates's) co., Lieut. Col. John Brooks's (7th) regt.; age, 23 (also given 24) yrs.; stature, 5 ft. 7 in.; complexion, light (also given freckled); hair, red (also given sandy and light); occupation, cooper; birthplace, Berkley (also given Yarmouth); residence, Barnstable (also given Yarmouth); enlisted Oct. -, 1779, by Capt. Redding; enlistment, during war; also, Private, Capt. Joseph Bates's co., Lieut. Col. John Brooks's (7th) regt.; muster rolls for Jan.-May, 1781, dated West Point; reported on the guard boat in Jan., 1781; also, muster rolls for June and July, 1781; reported on command at West Point; also, muster roll for Aug., 1781, dated Camp at Peekskill; reported on command at West Point; also, muster roll for Sept., 1781; also, muster roll for Oct. and Nov., 1781, dated York Huts; also, muster rolls for Dec, 1781-Feb., 1782, dated York Huts and sworn to at West Point; also, Capt. Hastings's CO., Lieut. Col. Brooks's regt.; list of men who died or were discharged subsequent to Jan. 1, 1781; said Maker discharged June 10, 1783, by Gen. Washington, term of enlistment having expired; also, list of men entitled to honorary badges for long and faithful service; said Maker served from Jan. -, 1777; entitled to 1 and 2 stripes.

**Maker, James**, Salem (also given Harwich). List of men raised to serve in the Continental Army from 1st Essex Co. regt.; residence, Salem; engaged for town of Salem; joined Capt. Page's co. Col. Francis's regt.; term, 3 years; also, list of men mustered by Joseph Otis, Muster Master for Barnstable Co., dated Barnstable, Feb. 21, 1777; Capt. James Davis's co., Col. Gamaliel Bradford's regt.; engaged for town of Harwich; mustered Feb. 18, 1777; term, 3 years; also, Private, 5th CO., Col. Gamaliel Bradford's regt.; Continental Army pay accounts for service from Feb. 15, 1777, to March 10, 1778; reported deceased; also, Capt. Samuel Page's co., Col. Ebenezer Francis's regt.; subsistence allowed from date of enlistment, March 13, 1777, to time of marching to Bennington, April 8, 1777; credited with 39 days allowance, including allowance for travel (240 miles) on march to Bennington; also, Capt. John Lament's co. Col. Gamaliel Bradford's (12th) regt.; return [year not given]; residence, Harwich; enlisted for town of Harwich; mustered by County and Continental Muster Masters; also, same co. and regt.; return of men who were in camp on or before Aug. 15, 1777; joined May 1, 1777.

**Maker, Seth**. Private, Capt. John Russell's co.; marched July 28, 1776; service to Sept. 30, 1776, 2 mos. 2 days; company stationed at Martha's Vineyard for defence of seacoast; also, same co.; service from Sept. 30, 1776, to Nov. 22, 1776, 1 mo. 22 days; company raised for defence of seacoast and stationed at Martin's (Martha's) Vineyard under Maj. Barachiah Bassett; also, Capt. Abijah Bangs's CO., Col. Nathaniel Freeman's regt.; pay roll for Oct., 1777, dated Harwich; service, 31 days, on a secret expedition to Rhode Island.

**Mayo, Elkanah**. Private, Capt. Abijah Bangs's co., Maj. Zenas Winslow's (2d Barnstable Co.) regt.; service, 5 days, on alarms at Bedford and Falmouth in Sept., 1778; also, account dated [Harwich, Nov. 7, 1778], rendered by Capt. Abijah Bangs, of amounts due men who guarded prisoners from the [British] ship "Somerset" at Harwich, and thence to Yarmouth; service, 2 days.

**Mayo, Joshua**, Harwich. List of men belonging to Capt. Abijah Bangs's co. raised from various towns in Barnstable Co. dated Dorchester, Sept. 4, 1776; also, Private, Capt. Abijah Bangs's co. Col. Dike's regt.; pay roll for travel allowance from home and return, etc., dated Boston, Nov. 26, 1776; said Mayo credited with 4 days allowance; mileage to and from camp (174 miles) also allowed; also, same co. and regt.; abstract for gun and blanket money dated Boston, Feb. 24, 1777; also, same CO. and regt.; muster roll for Dec, 1776-Feb., 1777; enlisted Dec. 1 (?), 1776; regiment raised to serve until March 1, 1777.

## Revolutionary War Memorial for the Town of Harwich, Massachusetts

**Mayo, Thomas, 3d.** Private, Capt. Joshua Higgins's co., Maj. Zenas Winslow's regt.; service, 6 days, on an alarm at Bedford and Falmouth in Sept., 1778.

**McCloud, Anguish,** Harwich. Descriptive list of men raised to reinforce the Continental Army for the term of 6 months, agreeable to resolve of June 5, 1780, returned as received of Justin Ely, Commissioner, by Brig. Gen. John Glover, at Springfield, July 19, 1780; age, 32 yrs. ; stature, 5 ft. 8 in.; complexion, ruddy; engaged for town of Harwich ; marched to camp July 19, 1780, under command of Capt. Clark ; also, list of men raised for 6 months service and returned by Brig. Gen. Paterson as having passed muster in a return dated Camp Totoway, Oct. 25, 1780 ; also, pay roll for 6 months men raised by the town of Harwich for service in the Continental Army during 1780; marched July 8, 1780; discharged Dec. 8, 1780; service, 5 mos. 15 days, including travel (300 miles) home.

**McKee, James,** Harwich. List of men raised to serve in the Continental Army from 2d Barnstable Co. regt., as returned by Maj. Zenas Winslow and Capt. Abijah Bangs, dated Feb. 24, 1778; residence, Harwich; engaged for town of Harwich; joined Capt. G. Weeb's (Webb's) co.. Col. Shephard's regt.; term to expire in 1780.

**Merrill, Reuben,** Harwich. Private, Capt. Matthias Tobey's co., Col. Aaron Willard's regt. ; pay abstract for travel allowance, etc., from home to Ticonderoga, the place of rendezvous, dated Boston, Jan. 15, 1777; travel (283 miles) allowed said Merrill; also, same co. and regt.; pay abstract for travel allowance, etc., from place of discharge home, dated Boston, Jan. -, 1777; travel (331 miles) allowed said Merrill ; reported discharged at Fort Edward ; also, Capt. Joseph Franklin's co., Col. Nathan Tyler's regt. ; enlisted Oct. 22, 1779; discharged Dec. 31, 1779 ; service, 2 mos. 8 (also given 2 mos. 9) days, at Rhode Island ; also, same CO. and regt.; pay roll for Dec, 1779, sworn to at Rehoboth, allowing 21 days service at Rhode Island ; also, same co. and regt. ; pay roll for Dec, 1779, allowing 1 mo. 4 days service at Rhode Island, travel (89 miles) included.

**Merrill, Ripley,** Harwich. Private, Capt. Joseph Franklin's co., Col. Nathan Tyler's regt.; enlisted Oct. 22, 1779; discharged Dec. 31, 1779; service, 2 mos. 8 (also given 2 mos. 9) days, at Rhode Island; also, same co. and regt.; pay roll for Dec, 1779, sworn to at Rehoboth, allowing 21 day's service at Rhode Island; also, same co. and regt.; pay roll for Dec, 1779, allowing 1 mo. 4 days service at Rhode Island, travel (89 miles) included.

**Micah, Daniel,** Harwich. List of men raised to serve in the Continental Army from 2d Barnstable Co. regt., as returned by Maj. Zenas Winslow and Capt. Abijah Bangs, dated Feb. 24, 1778; residence, Harwich; engaged for town of Harwich joined Capt. J. Russell's co. Col. Bradford's regt.; term to expire in 1780.

**Mirick, Joshua,** Harwich. Capt. Abijah Bangs's co.; list dated Dorchester, Sept 4, 1776; company raised from various towns in Barnstable Co.

### Volume 11: MOR-PAZ

**Moses, David,** Harwich. Private, Capt. Matthias Tobey's co., Col. Aaron "Willard's regt. ; pay abstract for travel allowance, etc., from place of discharge home, dated Boston, Jan. -, 1777; 340 miles travel allowed said Moses; reported discharged at Fort Edward.

Mosses, David, Harwich. Private, Capt. Matthias Tobey's co.. Col. Aaron Willard's regt. ; pay abstract for travel allowance, etc., from home to place of rendezvous, Ticonderoga, dated Boston, Jan. 15, 1777 ; 292 miles travel allowed said Mosses.

**Myrick, Benjamin,** Harwich. Matross, Capt. John Gill's (6th) co. Col. Thomas Crafts's (Artillery) regt.; service from Feb. 1, 1777, to May 8, 1777, 3 mos. 7 days.

**Myrick, Joseph.** Private, Capt. Joshua Higgins's co., Maj. Zenas Winslow's regt.; service between Sept. 6, and Sept. 13, 1778, 3 days, on alarms at Bedford and Falmouth; o/.so, account dated Eastham, Nov. 8, 1778, rendered by

## Revolutionary War Memorial for the Town of Harwich, Massachusetts

said Myrick and others, for 1 day's service guarding prisoners belonging to the British ship " Somerset " at Eastham and thence to Harwich by order of Maj. Gideon Freeman.

**Myrick, Joshua**, Harwich. Private, Capt. Abijah Bangs's co. Col. Dike's regt.; pay roll for travel allowance from home and return, etc., dated Boston, Nov. 26, 1776; credited with 4 days allowance; mileage (174 miles) to and from camp also allowed; also, same co. and regt.; pay abstract for gun and blanket money, dated Boston, Feb. 24, 1777; also, same co. and regt. ; muster roll for Dec, 1776-Feb., 1777; enlisted Dec. 1, 1776; regiment raised to .serve until March 1, 1777.

**Myrick, Samuel**. Private, Capt. Abijah Bangs's co., Maj. Zenas Winslow's (2d Barnstable Co.) regt.; service, 7 days, on alarms at Bedford and Falmouth in Sept., 1778; also, account dated [Harwich, Nov. 7, 1778], rendered by Capt. Abijah Bangs, for amounts due men who guarded prisoners from the [British] ship " Somerset " at Harwich and thence to Yarmouth; service, 2 days.

**Nias, Isaac**, Harwich. List of men mustered by Joseph Otis, Muster Master for Barnstable Co.; Capt. "Webb's co. Col. Sheppard's regt.; engaged for town of Harwich; mustered March 28, 1777; term, 3 years; also, Private, Capt. George Webb's co. Col. William Sheppard's (. "d) regt.; Continental Army pay accounts for service from May 29, 1777, to Dec. 31, 1779; residence, Harwich; rt^so, same co. and regt.; pay rolls for Oct., 1778, March, and April, 1779, dated Providence; enlisted May 29 (also given May 27) , 1777 ; enlistment, during war; reported on command at the Western shore in March and April, 1779; also, Capt. Holbrook's co.. Col. Shepard's regt. ; Continental Army pay accounts for service from Jan. 1, 1780, to Dec. 31, 1780; also, Capt. Webb's CO., Col. William Shepard's (4th) regt. ; return for gratuities, dated Highlands, Feb. 24, 1780; also, Capt. David Holbrook's co., Col. Shepard's regt.; return made up for the year 1780; also, same co. and regt.; muster roll for May, 1781, dated West Point ; also, muster rolls for June-Sept., 1781 ; reported with Light Infantry from May, 1781 ; also, muster rolls for Oct., 1781-Jan. 1782, dated York Hutts; reported sick at the Southward in Oct. and Nov., 1781, sick but present in Dec, 1781, died Jan. 27, 1782.

**Nicorson (Nickerson) Barnabas**, Harwich. List of men raised to serve in the Continental Army from 2d Barnstable Co. regt., as returned by Maj. Zenas Winslow and Capt. Abijah Bangs, dated Feb. 24,1778; residence, Harwich; engaged for town of Harwich; joined Capt. G. "Webb's co. Col. Shephard's regt.; term to expire in 1780.

**Nickerson, Benjamin**. Private, Capt. Elijah Smalley's co., Maj. Zenas Winslow's regt.; service, 9 days, on an alarm at Bedford and Falmouth in Sept., 1778.

**Nickerson, Covell**. Private, Capt. Abijah Bangs's co., Col. Dike's regt. ; pay abstract for gun and blanket money, dated Boston, Feb. 24, 1777; also, same CO. and regt. ; muster roll for Dec, 1776-Feb., 1777; credited to town of Harwich; enlisted Dec. 13, 177(3; regiment raised to serve until March 1, 1777.

**Nickerson, David**, Harwich. Order payable to Capt. Samuel King, dated Hull, June 20, 1776, signed by said Nickerson and others, for advance pay, etc ; also, Private, Capt. Samuel King's co., Col. Jo.siah Whitney's regt.; service from May 23, 1776, 4 days preceding march, to Dec. 1, 1776, 6 mos. 12 days; rolls dated Camp at Hull; also, Capt. Thomas Nickerson's co., Maj. Zenas Winslow's regt. ; service, 6 days, on an alarm at Bedford and Falmouth in Sept., 1778; roll sworn to in Barnstable Co.

Nickorson, David, Harwich. Private, Capt. Benjamin Godfrey's co., Col. Josiah Whitney's regt.; arrived at destination May 10, 1777; discharged July 10, 1777; service, 2 mos. 11 days, at Rhode Island, travel (11 day's) included; 100 miles reported as distance from Harwich to place of destination ; enlistment, 2 months. Roll dated Boston Neck, South Kingston.

**Nickerson, Edward** (also given Elisha), Harwich. Private, Capt. Abijah Bangs's co. Col. Dike's regt. ; pay abstract for gun and blanket money, dated Boston, Feb. 24, 1777; also, same co. and regt.; muster roll for Dec, 1776- Feb., 1777; enlisted Dec. 13, 1776; regiment raised to .serve until March 1, 1777 ; also, Capt. Benjamin Godfrey's co..



## Revolutionary War Memorial for the Town of Harwich, Massachusetts

Col. Josiah Whitney's regt.; arrived at destination May 10, 1777 ; discharged July 10, 1777 ; service, 2 mos. 11 days, at Rhode Island, travel (11 days) included ; 100 miles reported as distance from Harwich to place of destination ; enlistment, 2 months; roll dated Boston Neck, South Kingston ; also, list of men mustered by Nathaniel Barber, Muster Master for Suffolk Co., dated Boston, Feb. 14, 1779; Capt. Knapp's CO., Col. Shepard's regt.; also, Private, Capt. George Webb's co.. Col. William Sheppard's (3d) regt.; Continental Army pay accounts for service from March 15, 1778, to Dec 31, 1779 ; also, same co. and regt. ; muster roll for Oct., 1778, dated Camp at Providence ; term, during war ; reported on fatigue duty ; also, Capt. Webb's co., Col. Shepard's regt. ; muster roll for March and April, 1779, dated Providence; enlisted April 4 (also given Marcli 15), 1778; also, Capt. David Holbrook's CO., Col. William Shepard's (4th) regt.; Continental Army pay accounts for service from Jan. 1, 1780, to Dec. 31, 1780; also, Capt. Webb's CO., Col. Shepard's regt. ; return for gratuities, dated Highlands, Feb. 24, 1780 ; gratuity paid said Nickerson Jan. 29, 1780 ; also, Capt. Holbrook's co.. Col. Shepard's regt.; muster roll for May, 1781, dated West Point; reported with Light Infantry; also, muster rolls for June-Sept., 1781; reported on command with Light Infantry; also, muster rolls for Oct.-Dec, 1781, and Jan., 1782, dated York Hutt's; reported appointed Corporal in Jan., 1782 ; also. Corporal; muster roll for Feb., 1782, dated Hutts.

**Nicolson (Nickerson), "Ezekiel,"** Harwich. Fifer, Capt. Abijah Bangs's co., Col. Nathaniel Freeman's regt.; pay roll for Oct., 1777, dated Harwich; service, 31 days, on a secret expedition to Rhode Island.

**Nickerson, Jeremiah.** Private, Capt. Nathan Basset's co., Maj. Zenas "Winslow's regt.; service, 6 days, on an alarm at Bedford and Falmouth in Sept., 1778. Roll sworn to in Barnstable C

**Nicolson (Nickerson), Joshua,** Harwich. Corporal, Capt. Abijah Bangs's co. Col. Nathaniel Freeman's regt.; pay roll for Oct., 1777, dated Harwich; service, 31 days, on a secret expedition to Rhode Island.

**Nickerson, Seth,** Harwich. Corporal, Capt. Benjamin Godfrey's co., Col. Josiah Whitney's regt.; arrived at destination May 10, 1777; discharged July 10, 1777; service, 2 mos. 12 days, at Rhode Island, travel (12 days) included; 100 miles reported as distance from Harwich to place of destination; enlistment, 2 months. Roll dated Boston Neck, South Kingston.

**Nickerson, Silas.** Private, Capt. Elijah Smalley's co., Maj. Zenas Winslow's regt.; service, 4 days, on an alarm at Bedford and Falmouth in Sept., 1778.

Nicolson, Silas, Chatham. Private, Capt. Abijah Bangs's co. Col. Nathaniel Freeman's regt.; pay roll for Oct., 1777, dated Harwich; service, 16 days, on a secret expedition to Rhode Island.

**Nickerson, Thomas.** Captain, 7th (2d Harwich) co., 2d Barnstable Co. regt. of Mass. militia; list of officers chosen in said regiment, as returned by Joseph Doane; ordered in Council April 20, 1776, that said officers be commissioned; reported commissioned April 20, 1776; also, Captain, Maj. Zenas Winslow's regt.; service, 9 days, on an alarm at Bedford and Falmouth in Sept., 1778; roll sworn to in Barnstable Co.

**Nicolson (Nickerson) Uriah,** Harwich. Private, Capt. Abijah Bangs's co., Col. Nathaniel Freeman's regt.; pay roll for Oct., 1777, dated Harwich ; service, 31 days, on a secret expedition to Rhode Island.

**Nye, Joseph.** Private, Capt. Benjamin Berry's (Harwich) co., Maj. Zenas Winslow's regt.; service, 6 days, on an alarm at Bedford and Falmouth Sept. 7, 1778; roll sworn to in Barnstable Co.; also, account of blank commissions delivered the committees appointed to raise men to go to Canada [year not given]; said Nye reported as belonging to committee for Barnstable Co.

**Padduck, Reuben.** Private, Capt. Benjamin Berry's (Harwich) co., Maj. Zenas Winslow's regt.; service, 7 days, on an alarm at Bedford and Falmouth Sept. 7, 1778. Roll sworn to in Barnstable Co.

**Pain, Jonathan.** Private, Capt. Benjamin Berry's (Harwich) co., Maj. Zenas Winslow's regt.; service, 5 days, on an alarm at Bedford and Falmouth Sept. 7, 1778.

## Revolutionary War Memorial for the Town of Harwich, Massachusetts

**Paine, "Huching."** Private, Capt. Abijah Bangs's co. Col. Dike's regt.; pay abstract for gun and blanket money, dated Boston, Feb. 24, 1777; also, same CO. and regt.; muster roll for Dec, 1776-Feb., 1777; credited to town of Harwich; enlisted Dec. 13, 1776 ; regiment raised to serve until March 1, 1777. [See Hutchens Pane.]

**Paine, Sylvanus,** Harwich. List of men belonging to Capt. Abijah Bangs's co. raised from various towns in Barnstable Co., dated Dorchester, Sept. 4, 1776; also. Private, Capt. Abijah Bangs's co., Col. Dike's regt.; pay roll for travel allowance from home and return, etc., dated Boston, Nov. 26, 1776; said Paine credited with 4 days allowance; mileage to and from camp (174 miles) also allowed; also, same co. and regt.; muster roll for Dec, 1776-Feb., 1777; enlisted Dec. -, 1776; regiment raised to serve until March 1, 1777.

Pain, Sylvanus. Account dated [Harwich, Nov. 7, 1778], rendered by Capt. Abijah Bangs, for amounts due men who guarded prisoners from the [British] ship " Somerset " at Harwich, and thence to Yarmouth; service, 2 days.

**Parker, Josiah,** Harwich. List of men belonging to Capt. Abijah Bangs's co. raised from various towns in Barnstable Co., dated Dorchester, Sept. 4, 1776; also, Private, Capt. Abijah Bangs's co. Col. Dike's regt.; pay roll for travel allowance from home and return, etc., dated Boston, Nov. 26, 1776; said Parker credited with 4 days allowance ; mileage (174 miles) to and from camp also allowed ; also, same co. and regt. ; muster roll for Dec, 1776-Feb., 1777; enlisted Dec. 1, 1776; regiment raised to serve until March 1, 1777.

### Volume 12: PEA-RAZ

**Phillips, Daniel,** Harwich (also given Barnstable). List of men mustered by Joseph Otis, Muster Master for Barnstable Co., dated Barnstable, March 4, 1777; Capt. James Davis's co. Col. Gamaliel Bradford's regt.; residence, Harwich; mustered March 3, 1777; enlistment, 3 years; reported received State and Continental bounties; also, Private, 5th co. Col. Gamaliel Bradford's regt.; Continental Army pay accounts for service from Jan. 24, 1777, to Jan. 25, 1778; residence, Barnstable; reported deceased ; also, Capt. John Russell's CO., Col. Bradford's regt.; subsistence allowed from date of entering service Feb. 24 [1777], to March 21 [1777] ; credited with 37 days subsistence, including allowance for 11 days (220 miles) travel on march from Boston to Bennington; also, Capt. John Lamont's co.. Col. Bradford's (12th) regt.; return [year not given]; residence, Harwich; enlisted for town of Harwich; mustered by County and Continental Muster Masters; also, same co. and regt.; return of men who were in camp on or before Aug. 15, 1777; joined April 7, 1777; reported died July 25, 1778.

**Phillips, Joseph,** Harwich. Private, Capt. Abijah Bangs's co. Col. Nathaniel Freeman's regt.; pay roll for Oct., 1777; service, 31 days, on a secret expedition to Rhode Island.

**Phinney, James.** Private, Capt. Benjamin Berry's (Harwich) co., Maj. Zenas Winslow's regt.; service, 5 days, on an alarm at Bedford and Falmouth Sept. 7, 1778. Roll sworn to in Barnstable Co.

### Volume 13: REA-SEY

**Remick, Freeman.** Private, Capt. Benjamin Berry's (Harwich) co., Maj. Zenas Winslow's regt. ; service, 7 days, on an alarm at Bedford and Falmouth Sept. 7, 1778.

Remsick, Freeman, Harwich. Private, Capt. Matthias Tohey's co. Col. Aaron Willard's regt.; pay abstract for travel allowance, etc., from place of discharge home, dated Boston, Jan. -, 1777; 338 miles travel allowed said Remsick ; reported discharged at Fort Edward. [See Truman Remick.]

## Revolutionary War Memorial for the Town of Harwich, Massachusetts

**Remick, Truman**, Harwich. Private, Capt. Matthias Tobey's co., Col. Aaron Willard's regt.; pay abstract for travel allowance, etc., from home to place of rendezvous, Ticonderoga, dated Boston, Jan. 15, 1777; 290 miles travel allowed said Remick.

**Rider, Benjamin**, Harwich (also given Greenwich and Boston). Private, Capt. Isaiah Higgins's CO., Col. Thomas Marshall's regt. ; return for mileage, advance pay for 1 month from June 6, 1776, etc., dated Boston, June 17, 1776; mileage from camp (90 miles) allowed said Rider ; regiment stationed at Boston ; also, same co. and regt. ; service from Nov. 1, 1776, to time of discharge, 1 mo. ; also, list of men raised to serve in the Continental Army from 2d Barnstable Co. regt., as returned by Capt. Abijah Bangs and Maj. Zenas Winslow ; residence, Harwich; engaged for town of Harwich; joined Capt. G. Webb's co.. Col. Sheppard's regt. ; term to expire in 1780; also, list of men mustered by Joseph Otis, Muster Master for Barnstable Co., dated April 14, 1777; Capt. George "Webb's CO., Col. Sheppard's regt. ; mustered April 12, 1777; ten<sup>^</sup>, during war ; reported received State bounty; also, Private, Capt. George Webb's co., Col. William Sheppard's (3d) regt. ; Continental Army pay accounts for service from April 4, 1777, to Dec. 31, 1779; also, same co. and regt. ; return [year not given] ; mustered by Joseph Otis, State Muster Master, and by a Continental Muster Master ; also, same co. and regt. ; muster rolls for Oct., 1778, March and April, 1779, dated Camp at Providence ; enlisted April 4 (also given April 1) , 1777; reported on command at the Western shore in March and April, 1779; also, Capt. David Holbrook's co.. Col. William Shepard's (4th) regt. ; Continental Army pay accounts for service from Jan. 1, 1780, to Dec. 31, 1780; re- ported transferred to corps of invalids Dec. 30, 1780; also, Capt. Webb's co., Col. Shepard's regt.; return for gratuity, dated Highlands, Feb. 24, 1780; gratuity paid said Rider Jan. 29, 1780; also, list of United States pensioners made up to Dec. 31, 1787, as returned by John Lucas, Commissary of Pensions ; Capt. Webb's CO., regiment of invalids; age, 62 years; residence, Boston; re- ^ ported disabled by being debilitated in the service; pensioned Sept. 1, 1782; also, list of men entitled to \$20 or 200 acres of land, agreeable to resolve of March 5, 1801; 4th Mass. regt. ; residence, Greenwich.

**Rider, Daniel**, Harwich. Private, Capt. Abijah Bangs's co., Col. Nathaniel Freeman's regt.; pay roll for Oct., 1777, dated Harwich; service, 31 days, on a secret expedition to Rhode Island.

**Robbens, (Robbins) Enoch**, Harwich. Private, Capt. Joseph Griffith's co. Col. John Jacobs's regt.; enlisted June 16, 1778; service, 6 mos. 19 days; enlistment to expire Jan. 1, 1779.

**Robbins, Abner**, Harwich. Private, Capt. Abijah Bangs's co. Col. Nathaniel Freeman's regt.; pay roll for Oct., 1777, dated Harwich ; service, 31 days, on a secret expedition to Rhode Island ; also, Capt. Benjamin Berry's (Harwich) CO., Maj. Zenas "Winslow's regt. ; service, 3 days, on an alarm at Bedford and Falmouth Sept. 7, 1778.

**Robbins, William** (also given William, Jr.). Descriptive list of men raised to reinforce the Continental Army for the term of 6 months, agreeable to resolve of June 5, 1780, returned as received of Justin Ely, Commissioner, by Brig. Gen. John Glover, at Springfield, July 19, 1780; age, 17 yrs. ; .stature, 5 ft. 8 in. ; complexion, ruddy ; engaged for town of Harwich ; marched to camp July 19, 1780, under command of Capt. Clark ; also, pay roll for 6 months men raised by the town of Harwich for service in the Continental Army during 1780; marched to camp July 8, 1780; discharged Dec. 8, 1780; service, 5 mos. 15 days, including travel (300 miles) home.

Robins, "William, Harwich. List of men raised for the 6 months service and returned by Brig. Gen. Paterson as having passed muster in a return dated Camp Totoway, Oct. 25, 1780.

Robins, William. Private, Capt. Benjamin Berry's (Harwich) co., Maj. Zenas Winslow's regt.; service, 3 days, on an alarm at Bedford and Falmouth Sept. 7, 1778.

**Rogers, Aaron**. Private, Capt. Abijah Bangs's co., Maj. Zenas Winslow's (2d Barnstable Co.) regt.; service, 5 days, on alarms at Bedford and Falmouth in Sept., 1778.

**Rogers, Abner**. Private, Capt. Abijah Bangs's co., Maj. Zenas "Winslow's (2d Barnstable Co.) regt. ; service, 5 days, on alarms at Bedford and Falmouth in Sept., 1778.

## Revolutionary War Memorial for the Town of Harwich, Massachusetts

**Rogers, Daniel**, Harwich. Private, Capt. Joseph Griffith's co. Col. John Jacobs's regt.; enlisted June 16, 1778; service, 6 mos. 19 days; enlistment to expire Jan. 1, 1779.

Rogors, Daniel, Harwich. Private, Capt. Benjamin Godfrey's co., Col. Josiah "Whitney's regt.; arrived at destination May 10, 1777; discharged July 10, 1777; service, 2 mos. 11 days, at Rhode Island, travel (11 days) included, 100 miles reported as distance from Harwich to place of destination; enlistment, 2 months. Roll dated Boston Neck, South Kingston.

**Rogers, Gideon**. Private, Capt. Joshua Higgins's co., Maj. Zenas "Winslow's regt.; service between Sept. 6, and Sept. 13, 1778, 3 days, on alarms at Bedford and Falmouth.

**Rogers, Henry**, Colrain (also given Harwich). List of men raised to serve in the Continental Army, as returned by Capt. Hugh McClallen; residence, Colrain; engaged for town of Colrain; joined Capt. Toogood's co. Col. Nickson's regt.; term, 3 years, to expire Jan. -, 1780; also, list of men raised to serve in the Continental Army from 5th Hampshire Co. regt., endorsed "Colo David Fields Return; " also, Private, Capt. William Toogood's (5th) co. Col. Thomas Nixon's 6th (also given 5th) regt.; Continental Army pay accounts for service from May 15, 1777, to Dec. 31, 1779; also, same co. and regt.; return of men who were in camp on or before Aug. 15, 1777, and who had not been absent subsequently except on furlough, etc., certified at Camp near Peekskill, Feb. 16, 1779; also, (late) Capt. Toogood's co. Col. Nixon's regt.; muster roll for May, 1779, dated Highlands; enlisted May 15, 1777; reported on command at Fishkill; also, same co. and regt.; payrolls for June-Oct., 1779; also, same CO. and regt.; account for clothing for the year 1780; receipt for said clothing, dated Peekskill, Dec. 5, 1779; also, Capt. Benjamin Heywood's co.. Col. Nixon's regt.; pay rolls for Nov. and Dec, 1779; also, Capt. Heywood's (5th) CO., Col. Nixon's regt.; Continental Army pay accounts for service from Jan. 1, 1780, to May 16, 1780; residence, Harwich; reported discharged May 16 (also given May 26), 1780.

**Rogers, John**, Harwich. List of men raised to serve in the Continental Army from 2d Barnstable Co. regt., as returned by Maj. Zenas Winslow and Capt. Abijah Bangs, dated Feb. 24, 1778; residence, Harwich; engaged for town of Harwich.

**Rogers, John, Jr.**, Harwich. Private, Capt., Joseph Griffith's co. Col. John Jacobs's regt.; enlisted June 20, 1778; service, 6 mos. 15 days; enlistment to expire Jan. 1, 1779.

Rogers, John, Harwich. Private, Capt. Joseph Griffith's co., Col. John Jacobs's regt.; enlisted June 16, 1778; service, 6 mos. 19 days; enlistment to expire Jan. 1, 1779.

**Rogers, Jonathan**, Harwich. Petition dated Camp at Hull, Sept. 17, 1776, signed by said Rogers and others belonging to battalion stationed at Hull, asking for increase and payment of wages; also, Private, Capt. Samuel King's co. Col. Josiah "Whitney's regt.; service from May 23, 1776, 4 days preceding march, to Dec. 1, 1776, 6 mos. 12 days; rolls dated Camp at Hull.

ROBGRERS, Jonathan. Account dated [Harwich, Nov. 7, 1778], rendered by Capt. Abijah Bangs, for amounts due men who guarded prisoners from the [British] ship "Somerset" at Harwich and thence to Yarmouth; service, 2 days.

**Rogers, Moses**. Private, Capt. Joshua Higgins's co., Maj. Zenas Winslow's regt.; service from Sept. 6 to Sept. 13, 1778, 6 days, on alarms at Bedford and Falmouth.

Rogers, Moses. Private, Capt. Abijah Bangs's co., Maj. Zenas Winslow's (2d Barnstable Co.) regt.; service, 5 days, on alarms at Bedford and Falmouth in Sept., 1778.

**Ross, Enoch**, Barnstable (also given Harwich). Private, 5th co. Col. Gamaliel Bradford's regt.; Continental Army pay accounts for service from Jan. 16, 1777, to March 29, 1778; residence, Barnstable; reported deceased; also, Capt. John Russell's co., Col. Bradford's regt.; subsistence allowed from date of entering service, Jan. 16 [1777], to March

## Revolutionary War Memorial for the Town of Harwich, Massachusetts

21 [1777]; credited with 76 days subsistence, including allowance for 11 days (220 miles) travel on march from Boston to Bennington; also, Capt. John Lament's co.. Col. Bradford's (12th) regt. ; return [year not given] ; residence, Harwich ; enlisted for town of Harwich ; enlistment, 3 years ; mustered by County and Continental Muster Masters; also, same co. and regt. ; return of men who were in camp on or before Aug. 15, 1777, etc. ; joined May 1, 1777; reported died March -, 1778.

**Ryder, Benjamin**, Harwich. Private, Capt. Isaiah Higgins's co.. Col. Thomas Marshall's regt.; enlisted June 6, 1776; service to Oct. 31, 1776, 4 mos. 26 days.

**Seabrew, David**. Private, Capt. Abijah Bangs's co., Col. Dike's regt.; muster roll for Dec, 1776-Feb., 1777; credited to town of Harwich; enlisted Dec. 13, 1776; regiment raised to serve until March 1, 1777,

Sebrew, David. Private, Capt. Benjamin Berry's (Harwich) co., Maj. Zenas "Winslow's regt.; service, days, on an alarm at Bedford and Falmouth Sept. 7, 1778.

**Sears, Jonathan**, Harwich. Private, Capt. Thomas Hamilton's co.; enlisted July 10, 1775; service to Dec. 31, 1775, 6 mos. 7 days; company stationed in Barnstable Co. for defence of seacoast; also, list of men belonging to Capt. Abijah Bangs's co. raised from various towns in Barnstable Co., dated Dorchester, Sept. 4, 1776; also. Sergeant, Capt. Abijah Bangs's co. Col. Dike's regt.; pay roll for travel allowance from home and return, etc., dated Boston, Nov. 26, 1776; credited with 4 days allowance; mileage (174 miles) to and from camp also allowed; also, same co. and regt. ; pay abstract for gun and blanket money, dated Boston, Feb. 24, 1777; also, same co. and regt.; muster roll for Dec, 1776-Feb., 1777; engaged Dec. 15, 1776; regiment raised to serve until March 1, 1777; also. Private, Capt. Benjamin Berry's (Harwich) co., Maj. Zenas Winslow's regt.; service, 3 days, on an alarm at Bedford and Falmouth Sept. 7, 1778.

**Sears, Reuben**. Private, Capt. Benjamin Berry's (Harwich) co., Maj. Zenas "Winslow's regt.; service, 7 days, on an alarm at Bedford and Falmouth Sept. 7, 1778.

**Sears, Roland**. Corporal, Capt. Benjamin Berry's (Harwich) co., Maj. Zenas Winslow's regt.; service, 7 days, at Bedford and Falmouth on an alarm Sept. 7, 1778.

**Sears, Stephen**. Private, Capt. Benjamin Berry's (Harwich) co., Maj. Zenas Winslow's regt.; service, 5 days, on an alarm at Bedford and Falmouth Sept. 7, 1778.

**Sears, Willard**. Private, Capt. Benjamin Berry's (Harwich) co., Maj. Zenas Winslow's regt.; service, 5 days, on an alarm at Bedford and Falmouth Sept. 7, 1778.

### Volume 14: SHA-STH

**Small, Benjamin**, 3d. Private, Capt. Seth Clark's co.; service between July 1, 1775, and Dec. 31, Small, Elijah. Captain, 13th (4th Harwich) co., 2d Barnstable Co. regt. of Mass. militia; list of officers chosen in said regiment, as returned by Joseph Doane; ordered in Council April 20, 1770, that said officers be commissioned ; reported commissioned April 20, 1776. [See Elijah Smalley.]

**Small, John**. 2d Lieutenant, Capt. Elijah Small's 13th (4th Harwich) co., 2d Barnstable Co. regt. of Mass. militia; list of officers chosen in said regiment, as returned by Joseph Doane ; ordered in Council April 20, 1776, that said officers be commissioned ; reported commissioned April 20, 1776.

**Smith, Charles**, Harwich. Corporal, Capt. Isaiah Higgins's co. Col. Thomas Marshall's regt.; abstract for advance pay for 1 month, etc., due certain men who had joined said company subsequent to last previous return order for payment of amount of abstract, dated Long Island, Sept. 2, 1776, and signed by Capt. Higgins; also, same co. and

## Revolutionary War Memorial for the Town of Harwich, Massachusetts

regt.; entered service June 12, 1776; service to Oct. 31, 1776, 4 mos. 20 days; also, same co. and regt.; service from Nov. 1, 1776, to time of discharge, 1 mo.

Smith, Charles. Private, Capt. Benjamin Berry's (Harwich) co., Maj. Zenas Winslow's regt.; service, 7 days, on an alarm at Bedford and Falmouth Sept. 7, 1778.

**Smith, Elkanah.** Private, Capt. Benjamin Berry's (Harwich) co., Maj. Zenas Winslow's regt.; service, 7 days, on an alarm at Bedford and Falmouth Sept. 7, 1778. Roll sworn to in Barnstable.

**Smith, Obed** (also given Obadiah). Private, Capt. Nathan Basset's co., Maj. Zenas Winslow's regt.; service, 6 days, on an alarm at Bedford and Falmouth in Sept., 1778. Roll sworn to in Barnstable Co.

Smith, Obed. Private, Capt. Thomas Nickerson's co., Maj. Zenas Winslow's regt.; service, 5 days, on an alarm at Bedford and Falmouth in Sept., 1778. Roll sworn to in Barnstable Co.

**Snow, Aaron,** Harwich. Order dated Hull, June 20, 1776, signed by said Snow, Private, and others, for advance pay, etc., payable to Capt. Samuel King; also, petition dated Camp at Hull, Sept. 17, 1776, signed by said Snow and others belonging to battalion stationed at Hull, asking for increase and payment of wages; also, Private, Capt. Samuel King's co.. Col. Josiah Whitney's regt. ; service from May 23, 1776, 4 days preceding march, to Dec. 1, 1776, 6 mos. 12 days, travel (90 miles) included ; rolls dated Camp at Hull ; also, Capt. Nathaniel Freeman's co., Lieut. Col. Enoch Hallett's regt.; entered service Aug. 19, 1780 ; discharged Oct. 31, 1780 ; service, 2 mos. 17 days, including 4 days (75 miles) travel home ; regiment raised in Barnstable Co. to reinforce Continental Army for 3 months.

**Snow, David,** Harwich. Private, Capt. Benjamin Godfrey's co. Col. Josiah Whitney's regt.; arrived at destination May 10, 1777 ; discharged July 10, 1777 ; service, 2 mos. 11 days, at Rhode Island, travel (11 days) included ; 100 miles reported as distance from Harwich to place of destination. Roll dated Boston Neck, South Kingston.

**Snow, Ebenezer,** Harwich. List of men raised to serve in the Continental Army from 2d Barnstable Co. regt., as returned by Capt. Abijah Bangs and Maj. Zenas Winslow ; residence, Harwich ; engaged for town of Harwich ; joined Capt. G. Weeb's co.. Col. Shephard's regt.; term to expire in 1780; also, list of men mustered by Joseph Otis, Muster Master for Barnstable Co. , dated Barnstable, March 14, 1777; Capt. Webb's co., Col. Shepard's regt.; mustered March 11, 1777; term, 3 years; reported received State bounty; also, Private, Capt. George Webb's co.. Col. William Sheppard's regt.; Continental Army pay accounts for service from Feb. 2, 1777, to Sept. 17, 1777; reported deceased ; also, same co. and regt; return [year not given] ; mustered by Joseph Otis, State Muster Master.

Snow, Ebenezer. 2d Lieutenant, Capt. Thomas Nickerson's 7th (2d Harwich) CO., 2d Barnstable Co. regt. of Mass. militia; list of officers chosen in said regiment, as returned by Joseph Doane, Esq. ; ordered m Council April 20, 1776, that said officers be commissioned ; reported commissioned April 20, 1776 ; also. Lieutenant, Capt. Thomas Nickerson's co., Maj. Zenas Winslow's regt.; service, 6 days, on an alarm at Bedford and Falmouth in Sept., 1778; roll sworn to in Barnstable Co.

**Snow, Edward,** Harwich. Private, Capt. Benjamin Godfrey's co. Col. Josiah Whitney's regt.; arrived at destination May 10, 1777; discharged July 10, 1777; service, 2 mos. 11 days, at Rhode Island, travel (11 days) included; 100 miles reported as distance from Harwich to place of destination. Roll dated Boston Neck, South Kingston.

Snow, Edward, Harwich. List of men raised to serve in the Continental Army from 2(1 Barnstable Co. regt., as returned by Capt. Abijah Bangs and Maj. Zenas Winslow; residence, Harwich; engaged for town of Harwich; joined Capt. G. Weeb's co. Col. Shephard's regt.; term to expire in 1780; also, list of men mustered by Joseph Otis, Muster Master for Barnstable Co., dated April 14, 1777 ; Capt. George Webb's co., Col. Shepard's regt. ; mustered April 12, 1777; term, 3 years; reported received State and Continental bounties; also, Private, Capt. George Webb's co.. Col. William Sheppard's (3d) regt.; Continental Army pay accounts for service from April 3, 1777, to Dec. 31, 1779 ; also, same CO. and regt.; return [year not

## Revolutionary War Memorial for the Town of Harwich, Massachusetts

given]; mustered by Joseph Otis, State Muster Master ; also, same co. and regt. ; muster roll for Oct., 1778, dated Camp Providence; enlistment, during war; also, same co. and regt.; muster roll for March and April, 1779, dated Providence; enlisted April 3, 1777; re-ported on command at the Western shore; also, Capt. Holebrook's co., Col. Shepard's regt. ; Continental Army pay accounts for service from Jan. 1, 1780, to Dec. 31, 1780; also, Capt. Webb's co., Col. Shepard's (4th) regt. ; return for gratuities, dated Highlands, Feb. 24, 1780 ; gratuity paid said Snow Jan. 29, 1780; a/so ,..Capt. David Holbrook's co., Col. Shepard's regt.; return for the year 1780; enlisted April 13, 1777; also, Capt. Holbrook's co., Col. Shepard's regt. ; muster roll for May, 1781, dated West Point ; reported on command with light infantry; also, muster rolls for June-Sept., 1781; reported on command with light infantry ; also, muster roll for Oct. and Nov., 1781, dated York Hutts ; reported died Sept. 1, 1781.

**Snow, Joseph.** Private, Capt. Benjamin Berry's (Harwich) co., Maj. Zenas Winslow's regt.; service, 7 days, on an alarm at Bedford and Falmouth Sept. 7, 1778. Roll sworn to in Barnstable Co.

**Snow, Joshua.** Private, Capt. Abijah Bangs's co. Col. Dike's regt.; pay abstract for gun and blanket money, dated Boston, Feb. 24, 1777 ; also, same co. and regt.; muster roll for Dec, 1776-Feb., 1777; credited to town of Harwich; enlisted Dec. 3, 1776 ; regiment raised to serve until March 1, 1777 ; also, Capt. Abijah Bangs's co., Maj. Zenas "Winslow's (2d Barnstable Co.) regt. ; service, 7 days, on alarms at Bedford and Falmouth in Sept., 1778; also, account dated [Harwich, Nov. 7, 1778], rendered by Cai)t. Abijah Bangs, for amounts due men who guarded prisoners from the [British] ship " Somerset " at Harwich, and thence to Yarmouth ; service, 2 days ; also, Corporal, Capt. Nathaniel Freeman's co., Lieut. Col. Enoch Hallet's regt. ; entered service Aug. 16, 1780; discharged Oct. 31, 1780; service, 2 mos. 20 days, including 4 days (75 miles) travel home ; regiment raised in Barnstable Co. to reinforce Continental Army for 3 months.

**Snow, Nathaniel.** Private, Capt. Joshua Higgins's co., Maj. Zenas Winslow's regt.; service between Sept. 6, and Sept. 13, 1778, 3 days, on alarms at Bedford and Falmouth.

Snow, Nathaniel. Private, Capt. Abijah Bangs's co., Maj. Zenas "Winslow's (2d Barnstable Co.) regt.; service, 5 days, on alarms at Bedford and Falmouth in Sept., 1778.

Snow, Nathaniel. Private, Capt. Thomas Nickerson's co., Maj. Zenas Winslow's regt.; service, 4 days, on an alarm at Bedford and Falmouth in Sept., 1778. Roll sworn to in Barnstable Co.

Snow, Nathaniel. Private, Capt. Elijah Smalley's co., Maj. Zenas "Winslow's regt.; service, 4 days, on an alarm at Bedford and Falmouth in Sept., 1778. Roll sworn to in Barnstable

**Snow, Reuben.** 2d Lieutenant, Capt. Abijah Bangs's 8th (3d Harwich) co., 2d Barnstable Co. regt. of Mass. militia; list of officers chosen in said regiment, as returned by Joseph Doane ; ordered in Council April 20, 1776, that said officers be commissioned ; reported commissioned April 20, 1776 ; also. Lieutenant, Capt. Benjamin Godfree's co. ; list dated Barnstable, Oct. 4, 1776, of officers and men raised from Barnstable Co. brigade to serve at Rhode Island, as returned by Brig. Joseph Otis to Maj. Gen. Warren; company raised in Chatham, Harwich, Truro, and Eastham ; also, Lieutenant, Capt. Abijah Bangs's CO., Maj. Zenas "Winslow's (2d Barnstable Co.) regt.; service, 5 days, on alarms at Bedford and Falmouth in Sept., 1778; also, 1st Lieutenant, Capt. Nathaniel Freeman's co., Lieut. Col. Enoch Hallet's regt.; entered service July 15, 1780 ; discharged Oct. 31, 1780 ; service, 3 mos. 21 days, including 4 days (75 miles) travel home ; regiment raised in Barnstable Co. to reinforce Continental Army for 3 months.

**Snow, Samuel,** Harwich. List of men raised to serve in the Continental Army from 2d Barnstable Co. regt., as returned by Capt. Abijah Bangs and Maj. Zenas Winslow ; residence, Harwich ; engaged for town of Harwich ; joined Capt. G. Webb's co., Col. Shephard's regt. ; term to expire in 1780; also, list of men mustered by Joseph Otis, Muster Master for Barnstable Co., dated March 14, 1777; Capt. Webb's co., Col. Shepard's regt.; mustered March 11, 1777; term, 3 years; also. Private, Capt. George Webb's co., Col. William Sheppard's regt.; Continental Army

## Revolutionary War Memorial for the Town of Harwich, Massachusetts

pay accounts for service from Feb. 2, 1777, to March 23, 1778 ; reported deceased ; also, same co. and regt. ; return [year not given] ; mustered by Joseph Otis, State Muster Master, and by a Continental Muster Master.

**Snow, Thomas.** Private, Capt. Benjamin Berry's (Harwich) co., Maj. Zenas Winslow's regt.; service, 4 days, on an alarm at Bedford and Falmouth Sept. 7, 1778. Roll sworn to in Barnstable Co.

**Snow, Thomas, Jr.** Private, Capt. Benjamin Berry's (Harwich) co., Maj. Zenas Winslow's regt.; service, 6 days, on an alarm at Bedford and Falmouth Sept. 7, 1778.

**Stephens, Thomas.** Private, Capt. Benjamin Berry's (Harwich) co., Maj. Zenas Winslow's regt. ; service, 7 days, on an alarm at Bedford and Falmouth Sept. 7, 1778.

### Volume 15: STI-TOZ

**Tobey, Hermon.** List of men mustered by Joseph Otis, Muster Master for Barnstable Co., dated Barnstable, March 4, 1777; Capt. James Davis's co. Col. Gamaliel Bradford's regt.; engaged for town of Harwich; mustered Feb. 27, 1777; term, 3 years; reported received State and Continental bounties.

Toby, Hammon (also given Harmon and Varnon), Harwich (also given Barnstable). List of men raised to serve in the Continental Army from 2d Barnstable Co. regt., as returned by Maj. Zenas Winslow and Capt. Abijah Bangs; residence, Harwich; engaged for town of Harwich; joined Capt. J. Russell's CO., Col. Bradford's regt.; term, 3 years, to expire in 1780; also, Private, 5th CO., Col. Bradford's (14th) regt.; Continental Army pay accounts for service from Feb. 15, 1777, to May 14, 1777; residence, Barnstable; reported deceased; also, Capt. John Russell's co. Col. Gamaliel Bradford's regt.; subsistence allowed from date of entering service, Feb. 24 [1777], to March 21 [1777]; credited with 37 days subsistence, including allowance for 11 days (220 miles) travel on march from Boston to Bennington; also, Capt. John Lamont's co. Col. Bradford's (12th) regt.; return of men who were in camp on or before Aug. 15, 1777, etc. ; joined April 7, 1777; reported died May 14, 1777

**Toby, Absalom.** Descriptive list of men raised to reinforce the Continental Army for the term of 6 months, agreeable to resolve of June 5, 1780, returned as received of Justin Ely, Commissioner, by Brig. Gen. John Glover, at Springfield, July 19, 1780; age, 16 yrs. ; stature, 5 ft. 2 in. ; engaged for town of Harwich ; marched to camp July 19, 1780, under command of Capt. Clark ; reported a mulatto; also, Private, Capt. Joseph Fox's (3d) co., 16th Mass. regt.; pay roll for June and July, 1780 ; also, pay roll for 6 months men raised by the town of Harwich for service in the Continental Army during 1780 ; marched to camp July 8, 1780; discharged Dec. 8, 1780; service, 5 mos. 15 days, including travel (300 miles) home.

Tobey, Absalom, Harwich. List of men raised for the 6 months service and returned by Brig. Gen. Paterson as having passed muster in a return dated Camp Totoway, Oct. 25, 1780.

### Volume 16: TRA-WHE

**Tripp, "Acus."** Corporal, Capt. Simeon Fowler's co., Col. Jonathan Reed's (1st) regt. of guards; muster roll dated Cambridge, May 9, 1778; enlistment, 3 months from April 2, 1778; also, same co. and regt.; entered service April 4, 1778; service to July 8, 1778, 3 mos. 3 days, at Cambridge ; also. Private, Capt. Elijah Smalley's co., Maj. Zenas Winslow's regt.; service, 6 days, on an alarm at Bedford and Falmouth in Sept., 1778 ; roll sworn to in Barnstable Co. [See Acus Trip.]

Trip, "Asus." Corporal, Capt. Seth Clark's co.; service between July 1, 1775, and Dec. 31, 1775, 6 mos. 10 days, in defence of seacoast. Roll sworn to in Barnstable Co. [See Acus Tripp.]



## Revolutionary War Memorial for the Town of Harwich, Massachusetts

**Trip (Tripp), Jonathan**, Harwich. Private, Capt. Samuel King's co., Col. Josiah Whitney's regt.; abstract for advance pay, etc., dated Camp at Hull, Aug. 30, 1776; also, same co. and regt.; service from Aug. 1, 1776, 4 days preceding march, to Dec. 1, 1776, 4 mos. 4 days, travel (90 miles) included; also, Capt. Benjamin Godfrey's co., Col. Josiah Whitney's regt; arrived at destination May 10, 1777; discharged July 10, 1777; service, 2 mos. 11 days, at Rhode Island, travel (11 days) included; 100 miles reported as distance from Harwich to place of destination; roll dated Boston Neck, South Kingston; also, list of men raised to serve in the Continental Army from 2d Barnstable Co. regt., as returned by Capt. Abijah Bangs and Maj. Zenas Winslow, dated Feb. 24, 1778; residence, Harwich; reported engaged for Rhode Island.

**Turner, Consider**. Private, Capt. Abijah Bangs's co. Col. Dike's regt.; pay abstract for gun and blanket money, dated Boston, Feb. 24, 1777; also, same CO. and regt.; muster roll for Dec, 1776-Feb., 1777; credited to town of Harwich; enlisted Dec. 15, 1776; regiment raised to serve until March 1, 1777

**Warner, William**, Harwich. List of men raised to serve in the Continental Army from 2d Barnstable Co. regt., as returned by Maj. Zenas Winslow and Capt. Abijah Bangs; residence, Harwich; engaged for town of Harwich; joined Capt. G. Webb's co., Col. Sheppard's regt.; term to expire in 1780; also, list of men mustered by Joseph Otis, Muster Master for Barnstable Co., dated April 14, 1777; Capt. George Webb's co., Col. Sheppard's regt.; mustered April 10, 1777; term, during war; reported received State bounty; also, Private, Capt. Webb's co., Col. William Sheppard's (.3d) regt.; Continental Army pay accounts for service from March 23, 1777, to Dec. 31, 1779; reported as serving 20 mos. 7 days as Private, 13 mos. 1 day as Corporal; also, same co. and regt.; return [year not given]; residence, Harwich; enlisted for town of Harwich; mustered by Joseph Otis, State Muster Master; also, same co. and regt.; muster roll for Oct., 1778, dated Camp at Providence; also, Corporal, same co. and regt.; muster roll for March and April, 1779, dated Providence; appointed Oct. 1, 1778; also, Capt. David Holebrook's co., Col. Shepard's (4th) regt.; Continental Army pay accounts for service from Jan. 1, 1780, to Dec. 31, 1780; enlisted March 25, 1777; also, Capt. David Holbrook's co., Col. Shepard's regt.; muster roll for May, 1781, dated West Point; also, muster rolls for June-Sept., 1781; reported on command at West Point in June, July, and Aug., 1781; also, muster roll for Oct. and Nov., 1781, dated York Hutts; reported reduced to Private Oct. 29, 1781; also, Private, Capt. Holbrook's co., Col. Shepard's regt.; muster roll for Dec, 1781, dated York Hutts; reported transferred to Capt. Webb's co. Dec. 1, 1781. [See William Warrenner.]

**Webb, Constant**, Harwich. Descriptive list of men raised to reinforce the Continental Army for the term of 6 months, agreeable to resolve of June 5, 1780, returned as received of Justin Ely, Commissioner, by Brig. Gen. John Glover, at Springfield, July 11, 1780; age, 13 yrs.; stature, 4 ft. 8 in.; complexion, ruddy; engaged for town of Harwich; arrived at Springfield July 10, 1780 inarched to camp July 11, 1780, under command of Capt. George Webb; also, list of men raised for the 6 months service and returned by Brig. Gen. Pater-son as having passed muster in a return dated Camp Totoway, Oct. 25, 1780; also, pay roll for 6 months men raised by the town of Harwich for service in the Continental Army during 1780; marched to camp July 8, 1780; discharged Dec. 8, 1780; service, 5 mos. 15 days, including travel (300 miles) home.

**Webb, George**. Lieutenant, Capt. Seth Clark's co.; engaged July 1, 1775; discharged Dec. 31, 1775; service, 6 mos. 16 days, in defence of seacoast; roll sworn to in Barnstable Co.; also, Captain, Col. William Shepard's 4th (also given 3d) regt.; Continental Army pay accounts for service from Jan. 1, 1777, to Dec. 31, 1780; also, letter dated Camp Valley Forge, May 1, 1778, signed by said Webb, Captain, and other officers of Col. Shepard's regt., requesting that application be made to the President of the Board of War for clothing granted them by resolve of March 1.3, 1778; also, Col. Shepard's regt.; muster roll for Oct., 1778, dated Camp at Providence; appointed Jan. 1, 1777; also, Captain, 6th CO., Col. Shepard's regt.; muster roll of field, staff, and commissioned officers for March and April, 1779, dated Providence; also, list of men raised to reinforce the Continental Army for the term of 6 months, agreeable to resolve of June 6, 1780, who marched from Springfield July 11, 1780, under the care of said Webb, Captain; also, Col. Shepard's regt.; return of officers for clothing, dated Salem, Aug. 28, 1779; also, Captain, 4th Mass. regt.; list of settlements of rank of Continental officers, dated West Point, made by a Board held for the

## Revolutionary War Memorial for the Town of Harwich, Massachusetts

purpose and confirmed by Congress Sept. 6, 1779; commissioned Jan. 1, 1777; also. Captain, 4th Mass. regt. Gen. Glover's brigade; return of officers, dated Boston, Dec. 14, 1780; also. Col. Shepard's regt.; returns of effectives, dated Sept. 28, Oct. 12, and Oct. 19, 1781; reported on command at the Southward by general order; also. Captain, 9th (Light Infantry) co. Col. Shepard's regt.; muster roll for Feb.-Nov., 1781, dated Hutts 1st Brigade ; reported on command with light infantry at the Southward in July, 1781, on command with light infantry in June and Aug., 1781; also, muster roll of field, staff, and commissioned officers for Oct. and Nov., 1781, dated York Hutts; also, muster rolls for Dec, 1781, Jan. and Feb., 1782, dated Hutts 1st Brigade and sworn to at West Point; also, returns of effectives, dated Cantonment 1st Brigade, Feb. 22, and March 1, 1782; reported on furlough in Massachusetts from Jan. 11, 1782, by leave of Gen. McDougall ; also, return dated West Point, Aug. 15, 1782, signed by said Webb, Captain Commandant, 4th Mass. regt., showing number of men in actual service and number of men whose terms were to expire on or before Dec. 31, 1782; also, Col. Shepard's regt. ; returns of effectives between Sept. 13, and Oct. 25, 1782, dated Verplanck's Point; reported on duty with light infantry; also, return of effectives, dated Nov. 15, 1782; re- ported with light infantry.

Weeks, Ebenezer. Private, Capt. Elijah Smalley's co., Maj. Zenas Winslow's regt.; service, 2 days, on an alarm at Bedford and Falmouth in Sept., 1778. Roll sworn to in Barnstable Co. Buried Island Pond

**Weekson, Shubael**, Harwich. Private, Capt. Benjamin Godfrey's co., Col. Josiah "Whitney's regt. ; arrived- at destination May 10, 1777; discharged July 10, 1777 ; service, 2 mos. 11 days, at Rhode Island, travel (11 days) included ; 100 miles reported as distance from Harwich to place of destination ; roll dated Boston Neck, South Kingston; also, Capt. Abijah Bangs's co., Col. Nathaniel Freeman's regt.; pay roll for Oct., 1777, dated Harwich; service, 31 days, on a secret expedition to Rhode Island.

**Whelding, Ebenezer**. Private, Capt. Benjamin Berry's (Harwich) co., Maj. Zenas "Winslow's regt. ; service, 5 days, on an alarm at Bedford and Falmouth Sept. 7, 1778.

### Volume 17: WHI-ZYR

**Wing, Allen**. Private, Capt. Benjamin Berry's (Harwich) co., Maj. Zenas Winslow's regt. ; service, 7 days, on an alarm at Bedford and Falmouth Sept. 7, 1778.

**Wing, Barnabas**. Private, Capt. Abijah Bangs's co., Maj. Zenas Winslow's (2d Barnstable Co.) regt. ; service, 5 days, on alarms at Bedford and Falmouth in Sept., 1778; also, account dated [Harwich, Nov. 7, 1778], rendered by Capt. Abijah Bangs, for amounts due men who guarded prisoners from the [British] ship " Somerset," at Harwich, and thence to Yarmouth ; service, 2 days.

**Wing, Jonathan**. Private, Capt. Benjamin Berry's (Harwich) co., Maj. Zenas "Winslow's regt. ; service, 2 days, on an alarm at Bedford and Falmouth Sept. 7, 1778.

**Wing, Stephen**. Private, Capt. Benjamin Berry's (Harwich) co., Maj. Zenas Winslow's regt. ; service, 6 days, on an alarm at Bedford and Falmouth Sept. 7, 1778.

**Wing, Thomas**, Chatham (also given Harwich). Order dated Hull, June 20, 1776, signed by said Wing, Private, and others, for advance pay, etc., payable to Capt. Samuel King; also, petition dated Camp at Hull, Sept. 17, 1776, signed by said Wing and others belonging to battalion stationed at Hull, asking for increase and payment of wages; also, Capt. Samuel King's co.. Col. Josiah Whitney's regt. ; service from May 23, 1776, 4 days preceding march, to Dec. 1, 1776, 6 mos. 12 days, travel (90 miles) included ; rolls dated Camp at Hull.

**Winslow, Joshua**. 2d Lieutenant, sloop " Wolfe " (privateer) ; petition signed by Samuel Doggett and others, in behalf of themselves and others, of Boston and Harwich, asking that Nathaniel Freeman be commissioned as commander of .said vessel ; resolved in Council Sept. 4, 1776, that a commission be issued.

## Revolutionary War Memorial for the Town of Harwich, Massachusetts

Winslow, Joshua. Private, Capt. Benjamin Berry's (Harwich) co., Maj. Zenas Winslow's regt.; service, 4 days, on an alarm at Bedford and Falmouth Sept. 7, 1778.

**Winslow, Kenelm.** Private, Capt. Benjamin Berry's (Harwich) co., Maj. Zenas Winslow's regt.; service, 5 days, on an alarm at Bedford and Falmouth Sept. 7, 1778.

**Winslow, Nathan.** Private, Capt. Benjamin Berry's (Harwich) co., Maj. Zenas Winslow's regt.; service, 7 days, on an alarm at Bedford and Falmouth Sept. 7, 1778.

**Wixon, Shubael.** Private, Capt. John Grannis's co.; entered service June 1, 1776; service to Aug. 31, 1776, 3 mos.; company stationed at Elizabeth Islands for defence of seacoast. Roll dated Tarpaulin Cove and sworn to in Barnstable Woodman, Benjamin, Harwich. List of men raised to serve in the Continental Army, as returned by Capt. Abijah Bangs and Maj. Zenas Winslow, dated Feb. 24, 1778; residence, Harwich; engaged for state of Rhode Island; term, during war.

**Woodman, Benjamin,** Harwich. List of men raised to serve in the Continental Army, as returned by Capt. Abijah Bangs and Maj. Zenas Winslow, dated Feb. 24, 1778; residence, Harwich ; engaged for state of Rhode Island ; term, during war.

**Young, Crocker,** Harwich. Private, Capt. Elisha Nye's co. ; service from Sept. 1, 1776, to Nov. 21, 1776, 2 mos. 21 days ; company stationed at Elizabeth Islands for defence of seacoast; also, list of men raised to serve in the Continental Army from 2d Barnstable Co. regt., as returned by Capt. Abijah Bangs and Maj. Zenas Winslow; residence, Harwich; engaged for town of Harwich; joined Capt. G. Webb's co., Col. Sheppard's regt. ; term to expire in 1780; also, list of men mustered by Joseph Otis, Muster Master for Barnstable Co., dated Barnstable, March 14, 1777 ; Capt. Webb's co.. Col. Sheppard's regt. ; mustered March 11, 1777 ; term, 3 years ; reported received State bounty ; also, Private, Capt. George Webb's co.. Col. William Sheppard's regt. ; Continental Army pay accounts for service from Feb. 2, 1777, to March 14, 1778 ; reported deceased also, same co. and regt. ; return [year not given] ; mustered by Joseph Otis, State Muster Master, and by a Continental Muster Master.

**Young, John,** Harwich. Corporal, Capt. Abijah Bangs's co., Col. Nathaniel Freeman's regt.; pay roll for Oct., 1777, dated Harwich; service, 31 days, on a secret expedition to Rhode Island.

Young, John, Chatham (also given Harwich). List of men raised by the town of Chatham to serve in the Continental Army, as returned by James Ryder, Lieutenant of 1st co., and the Selectmen, endorsed " Benja. Godfrey Nathan Basset Capts.;" residence, Chatham; engaged for town of Chatham; joined Capt. Webb's co., Col. Sheppard's regt.; term, 3 years, to expire in 1780; also, list of men mustered by Joseph Otis, Muster Master for Barnstable Co., dated Barnstable, May 31, 1777; Capt. Webb's co. Col. Sheppard's regt.; mustered May 20, 1777; reported received State and Continental bounties; also. Private, Capt. George Webb's co. Col. William Sheppard's regt.; Continental Army- pay accounts for service from May 15, 1777, to March 12, 1778 reported deceased; also, same co. and regt. ; return [year not given] ; residence, Harwich ; enlisted for town of Harwich ; mustered by Joseph Otis, State Muster Master, and by a Continental Muster Master. Burial E.H Union Cemetery Harwich

**Young, Samuel.** Private, Capt. Joshua Higgins's co., Maj. Zenas Winslow's regt.; service between Sept. 6, and Sept. 13, 1778, 3 days, on alarms at Bedford and Falmouth.

Young, Samuel. Account dated Eastham, Nov. 8, 1778, rendered by said Young and others, for 1 day's service guarding prisoners belonging to the British ship "Somerset" at Eastham and thence to Harwich by order of Maj. Gideon Freeman.

**Young, Simeon.** Private, Capt. Seth Clark's co.; service between July 1, 1775, and Dec. 31, 1775, 6 mos. 10 days, in defence of seacoast. Roll sworn to in Barnstable.