

WEQUASSETT RESORT & GOLF CLUB

SIGNATURE SUITE

2173 MA-28, HARWICH, MASSACHUSETTS 02645

PLANNING BOARD SUBMISSION SET

PREPARED BY:

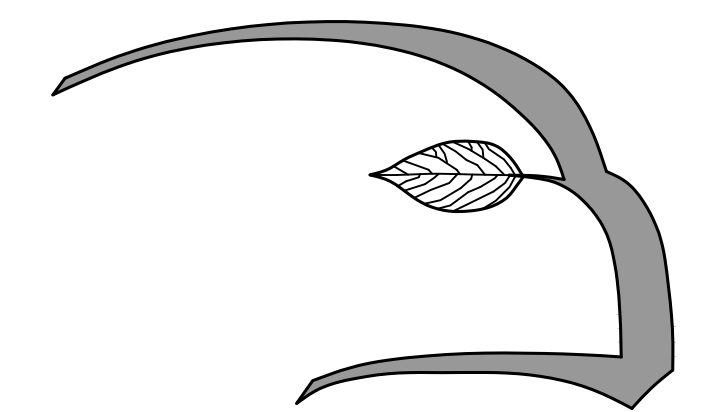

Hawk Design, Inc.

Landscape Architecture
Land Planning

Sagamore, MA

508-833-8800

info@hawkdesigninc.com

LIST OF DRAWINGS:

		SET DATE
L1.1	COTTAGE A & B LANDSCAPE PLAN	2/1/23
L1.2	COTTAGE A & B PARKING LANDSCAPE PLAN	2/1/23
L1.3	COTTAGE K LANDSCAPE PLAN	2/1/23
L1.4	COTTAGE A, B & K PLANT SCHEDULE	2/1/23
L1.5	PLANTING DETAILS & PLANTING NOTES	2/1/23
D1	CONSTRUCTION DETAILS	2/1/23

HAWK DESIGN, INC. 2023
THIS DRAWING AND ALL INFORMATION CONTAINED HEREIN IS PROPRIETARY INFORMATION OF HAWK DESIGN, INC. AND MAY NOT BE COPIED OR REPRODUCED EITHER IN WHOLE OR IN PART, BY ANY METHOD, WITHOUT WRITTEN PERMISSION OF HAWK DESIGN, INC.

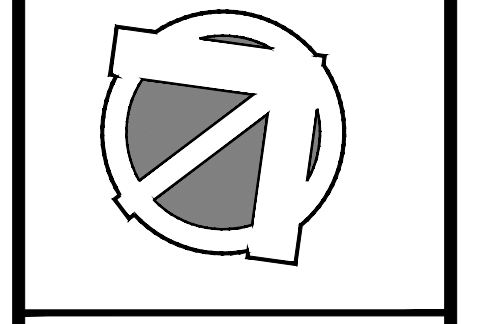

Date: 1/30/23

Revisions:
Num. Date Description

Wequasset Resort & Golf Club
Signature Suite
2178 MA-28 Harwich, Massachusetts 02645

Drawn By: DH Checked By: DH

Cottage A & B
Landscape Plan

Scale: 1" = 10'-0"

Sheet: **L1.1**

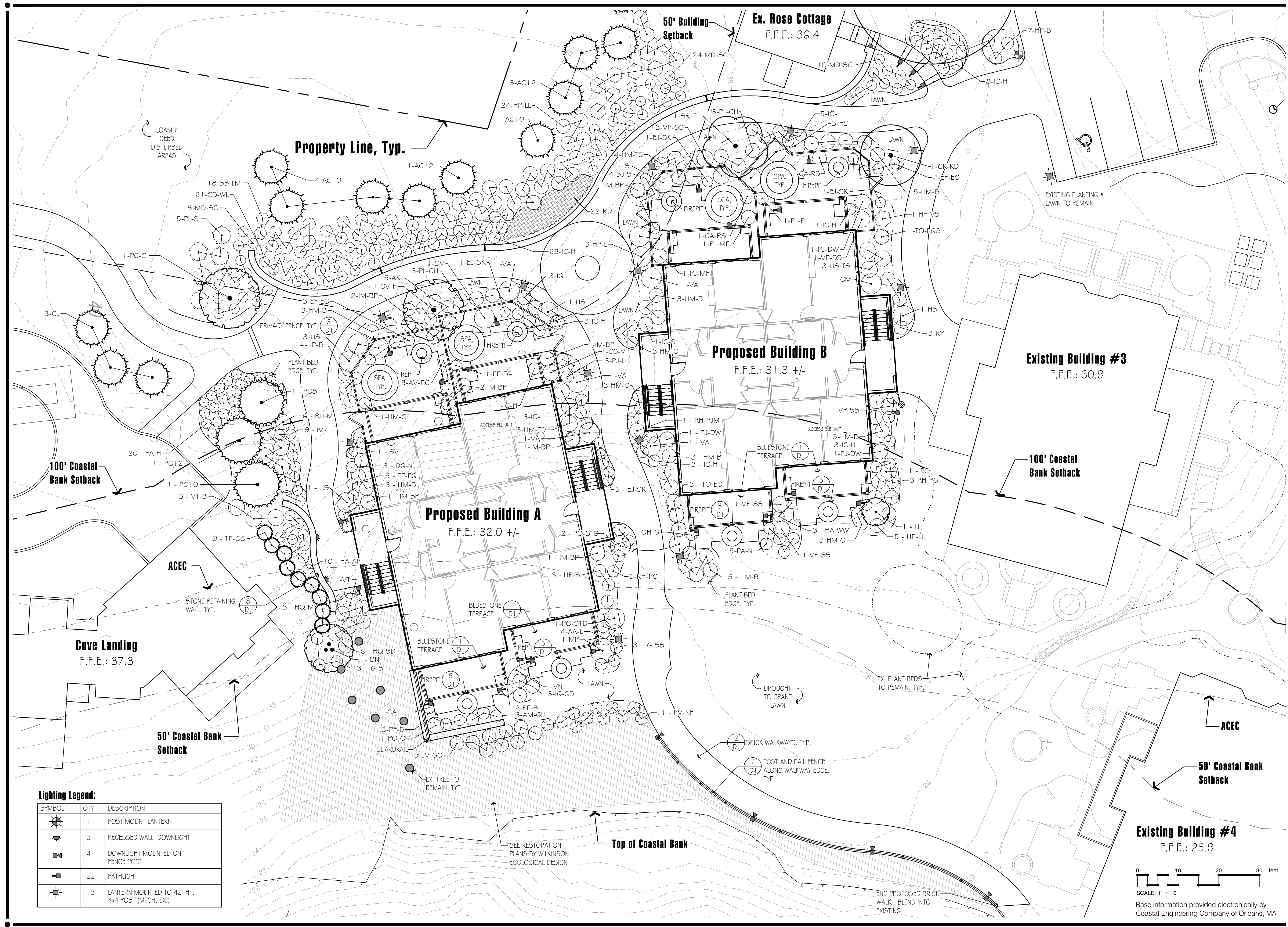

Lighting Legend:

SYMBOL	QTY	DESCRIPTION
	1	POST MOUNT LANTERN
	3	RECESSED WALL DOWNLIGHT
	4	DOWNLIGHT MOUNTED ON FENCE POST
	22	PATHLIGHT
	13	LANTERN MOUNTED TO 42" HT. 4x4 POST (MTCH. EX.)

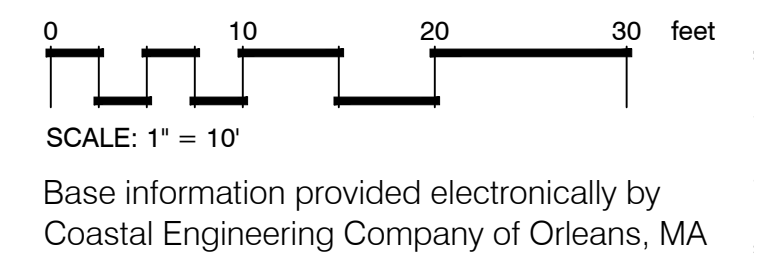

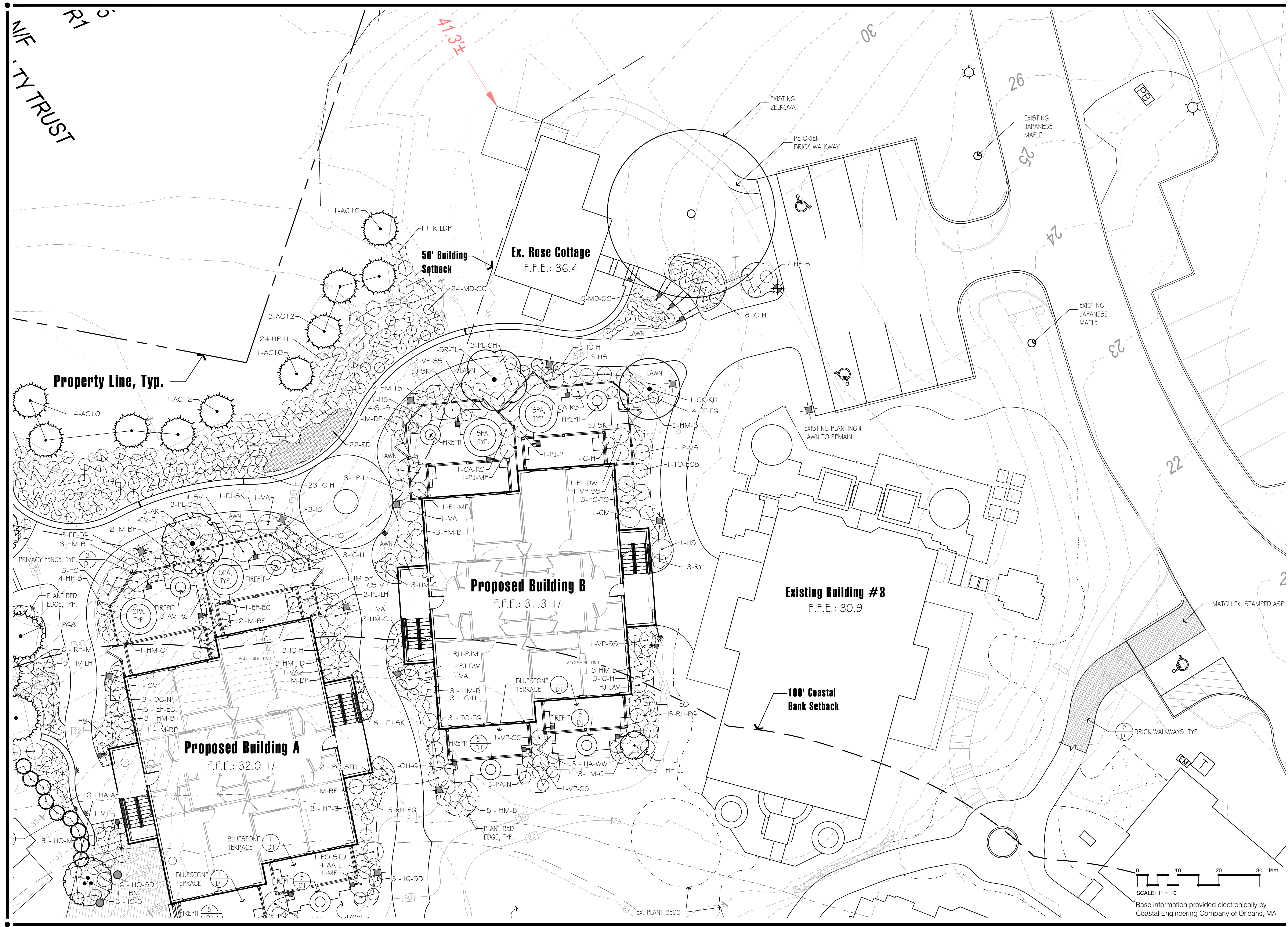

NIF
TY TRUST
R1 S



Hawk Design, Inc.
Landscape Architecture
Land Planning
Sagamore, MA
508-833-8800
info@hawkdesigninc.com

HAWK DESIGN, INC. 2023
THIS DRAWING AND ALL INFORMATION CONTAINED HEREIN IS PROPRIETARY INFORMATION OF HAWK DESIGN, INC. AND MAY NOT BE COPIED OR REPRODUCED EITHER IN WHOLE OR IN PART, BY ANY METHOD, WITHOUT WRITTEN PERMISSION OF HAWK DESIGN, INC.

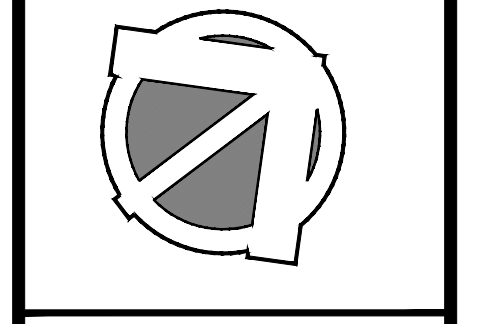

Date: 1/20/22

Revisions:
Num. Date Description

Wequasset Resort & Golf Club
Signature Suite
2178 MA-28 Harwich, Massachusetts 02645

Drawn By: DH Checked By: DH

**Cottage A & B
Parking
Landscape Plan**

Scale: 1" = 10'-0"

Sheet: **L1.2**

Base information provided electronically by Coastal Engineering Company of Orleans, MA

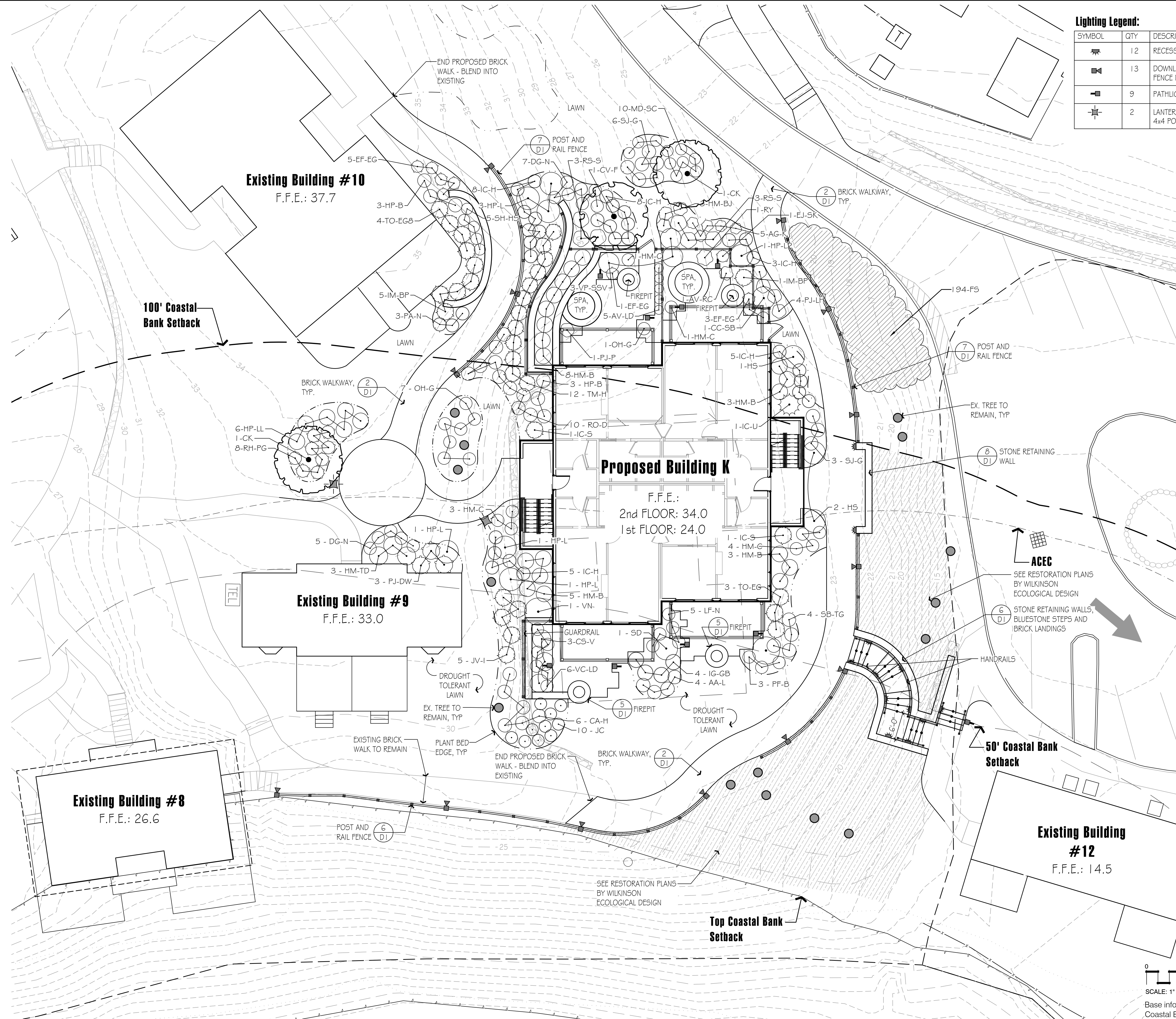

Lighting Legend:

SYMBOL	QTY	DESCRIPTION
	12	RECESSED WALL DOWNLIGHT
	13	DOWNLIGHT MOUNTED ON FENCE POST
	9	PATHLIGHT
	2	LANERN MOUNTED TO 42" HT. 4x4 POST (MTCH. EX.)

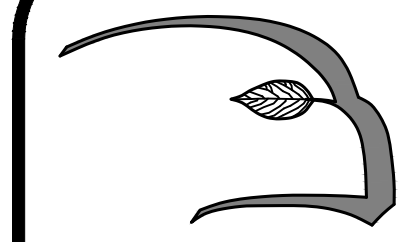

Hawk Design, Inc.
 Landscape Architecture
 Land Planning
 Sagamore, MA
 508-833-8800
 info@hawkdesigninc.com

HAWK DESIGN, INC. 2023
 THIS DRAWING AND ALL INFORMATION CONTAINED HEREON IS PROPRIETARY INFORMATION OF HAWK DESIGN, INC. AND MAY NOT BE COPIED OR REPRODUCED EITHER IN WHOLE OR IN PART, BY ANY METHOD, WITHOUT WRITTEN PERMISSION OF HAWK DESIGN, INC.

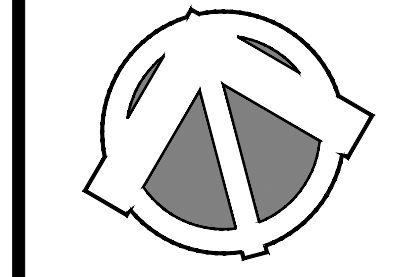

Date: 1/30/23

Revisions:
 Num. Date Description

Wequasset Resort & Golf Club
 Signature Suite
 2178 MA-28 Harwich, Massachusetts 02645

Drawn By: DH Checked By: DH

Cottage K
 Landscape Plan

Scale: 1" = 10'-0"

Sheet: **L1.3**

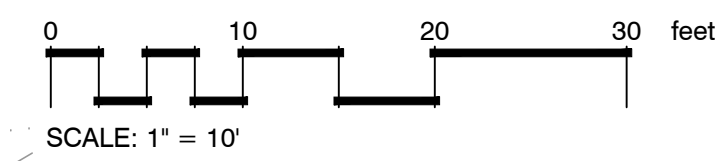

Base information provided electronically by Coastal Engineering Company of Orleans, MA

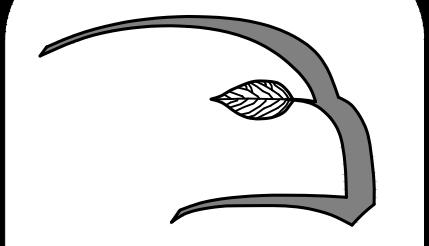

Hawk Design, Inc.
Landscape Architecture
Land Planning
Sagamore, MA
508-833-8800
info@hawkdesigninc.com

HAWK DESIGN, INC. 2023
THIS DRAWING AND ALL INFORMATION CONTAINED
HEREIN IS PROPRIETARY INFORMATION OF HAWK
DESIGN, INC. AND MAY NOT BE COPIED OR
REPRODUCED EITHER IN WHOLE OR IN PART, BY
ANY METHOD, WITHOUT WRITTEN PERMISSION OF
HAWK DESIGN, INC.

PLANT SCHEDULE BUILDINGS A & B					
TREES	QTY	BOTANICAL NAME	COMMON NAME	CONT	PLANT SIZE
BN	1	Betula nigra	River Birch Multi-Trunk	B & B	10-12' HT.
CK	1	Cladrastis kentukea	American Yellowwood	B & B	3-3.5" CAL.
LI	1	Lagerstroemia indica	Crape Myrtle	B & B	4-5' HT.
EVERGREEN TREES	QTY	BOTANICAL NAME	COMMON NAME	CONT	PLANT SIZE
PG10	1	Picea glauca	White Spruce	B & B	8-10' HT.
PG12	1	Picea glauca	White Spruce	B & B	8-10' HT.
PG8	1	Picea glauca	White Spruce	B & B	8-10' HT.
TP-GG	9	Thuja plicata 'Green Giant'	Green Giant Western Arborvitae	B & B	8-10' HT.
SHRUBS	QTY	BOTANICAL NAME	COMMON NAME	CONT	SIZE
AA-L	8	Aronia arbutifolia 'Lowscape'	Lowscape Red Chokeberry	Cont.	15-18" SPD.
AM-GH	3	Aronia melanocarpa 'UCONNAM012'	Ground Hug Black Chokeberry	Cont.	15-18" SPD.
CA-H	7	Clethra alnifolia 'Hummingbird'	Hummingbird Summersweet	Cont.	2' HT.
CS-V	3	Cornus sericea 'Variegata'	Variegated Red Twig Dogwood	B & B	3-4' HT.
DG-N	8	Deutzia gracilis 'Nikko'	Nikko Deutzia	Cont.	15-18" SPD.
EC	1	Enkianthus campanulatus	Enkianthus	B & B	3-4' HT.
EF-EG	5	Euonymus fortunei 'Emerald Gaiety'	Emerald Gaiety Wintercreeper	Cont.	15-18" SPD.
EJ-SK	5	Euonymus japonicus 'Silver King'	Silver King Euonymus	Cont.	2' HT.
HA-AP	10	Hypericum androsaemum 'Albury Purple'	Purple-leaf St. Johnswort	Cont.	18-24" SPD.
HA-VVV	3	Hydrangea arborescens 'NCHA5'	Invincibelle® Wee White Hydrangea	Cont.	15-18" HT.
HM-B	22	Hydrangea macrophylla 'Bloomstruck'	Bloomstruck Mophead Hydrangea	Cont.	2.5' HT.
HM-C	13	Hydrangea macrophylla 'Cityline'	Cityline Hydrangea	Cont.	18-24" SPD.
HM-TD	6	Hydrangea macrophylla 'Tokyo Delight'	Tokyo Delight Hydrangea	Cont.	2' HT.
HP-B	6	Hydrangea paniculata 'Bobo'	Bobo Panicle Hydrangea	Cont.	2' HT.
HP-L	3	Hydrangea paniculata 'Limelight'	Limelight Panicle Hydrangea	B & B	3-4' HT.
HP-LL	11	Hydrangea paniculata 'Little Lime'	Little Lime Panicle Hydrangea	Cont.	2' HT.
HQ-M	3	Hydrangea quercifolia 'Munchkin'	Munchkin Oakleaf Hydrangea	Cont.	15-18" SPD.
HQ-SD	6	Hydrangea quercifolia 'Sike's Dwarf'	Sike's Dwarf Oakleaf Hydrangea	Cont.	2' HT.
HS	3	Hibiscus syriacus	Rose of Sharon	B & B	5' HT.
IC-H	14	Ilex crenata 'Helleri'	Heller Japanese Holly	Cont.	15-18" SPD.
IC-S	2	Ilex crenata 'Steeds'	Steeds Japanese Holly	B & B	4' HT.
IG-GB	7	Ilex glabra 'Gem Box'	Gem Box Inkberry Holly	Cont.	2' HT.
IG-S	3	Ilex glabra 'Shamrock'	Shamrock Inkberry Holly	5 gal	2' HT.
IG-SB	3	Ilex glabra 'Strongbox'	Strongbox Holly	Cont.	2' HT.
IM-BP	3	Ilex x meserveae 'Blue Princess'	Blue Princess Holly	Cont.	2' HT.
IV-LH	9	Itea virginica 'Little Henry'	Virginia Sweetpire	Cont.	18-24" SPD.
JC	10	Juniperus conferta	Shore Juniper	Cont.	15-18" SPD.
JV-GO	9	Juniperus virginiana 'Grey Owl'	Grey Owl Eastern Redcedar	Cont.	18-24" SPD.
JV-I	5	Juniperus virginiana 'Idyllwild'	Idyllwild Eastern Redcedar	B & B	8-10' HT.
LF-N	5	Leucothoe fontanesiana 'Nana'	Dwarf Drooping Leucothoe	Cont.	15-18" SPD.
MP	2	Myrica pensylvanica	Northern Bayberry	B & B	3-4' HT.
OH-G	8	Osmanthus heterophyllus 'Goshiki'	Goshiki Holly Olive	B & B	2' HT.
PA-H	20	Pennisetum alopecuroides 'Hameln'	Hameln Fountain Grass	2 GAL	
PA-N	5	Picea abies 'Nidiformis'	Bird's Nest Norway Spruce	Cont.	15-18" SPD.
PF-B	8	Potentilla fruticosa 'Hachliss'	Bella Bellissima Bush Cinquefoil	Cont.	18-24" HT.
PJ-DW	5	Pieris japonica 'Dorothy Wycoff'	Dorothy Wycoff Japanese Pieris	Cont.	2' HT.
PO-C	1	Physocarpus opulifolius 'Mindia'	Coppertina Ninebark	Cont.	5' HT.
PO-STD	3	Physocarpus opulifolius	Ninebark on Standard	Cont.	5' HT.
PV-NF	11	Panicum virgatum 'Niagara Falls'	Niagara Falls Switch Grass	1 GAL	
RH-M	6	Rhododendron x 'Maxecat'	Maxecat Rhododendron	B & B	3' HT.
RH-PG	16	Rhododendron x 'Purple Gem'	Purple Gem Rhododendron	Cont.	15-18" SPD.
RH-PJM	1	Rhododendron x 'P.J.M. Compact'	PJM Compact Rhododendron	B & B	2' HT.
RO-D	10	Rosa 'Drift'	Drift Rose	Cont.	15-18" SPD.
SB-TG	4	Spiraea betulifolia 'Tor Gold'	Glow Girl® Birchleaf Spirea	Cont.	2' HT.
SD	1	Salix discolor	Pussy Willow	B & B	3-4' HT.
SJ-G	3	Spiraea japonica 'Goldmound'	Goldmound Japanese Spirea	Cont.	2' HT.
SV	1	Syringa vulgaris	Common Lilac	B & B	3-4' HT.
TM-H	12	Taxus x media 'Hicksii'	Hicks Yew	B & B	3-4' HT.
TO-EG	6	Thuja occidentalis 'Smaragd'	Emerald Green Arborvitae	B & B	6-8' HT.
VA	3	Vitex agnus-castus	Chaste Tree	B & B	3-4' HT.
VC-LD	6	Viburnum cassinoides 'Lil Ditty'	Lil' Ditty Viburnum	Cont.	15-18" SPD.
VN	2	Viburnum nudum	Possumhaw Viburnum	B & B	3-4' HT.
VP-SS	3	Viburnum plicatum 'Summer Snowflake'	Summer Snowflake Viburnum	B & B	3-4' HT.
VT	1	Viburnum trilobum	American Cranberrybush	B & B	3-4' HT.
VT-B	3	Viburnum trilobum 'Bailey Compact'	Bailey American Cranberrybush	B & B	3' HT.

PLANT SCHEDULE BUILDING K						
TREES	QTY	BOTANICAL NAME	COMMON NAME	CONT	PLANT SIZE	
CK	2	Cladrastis kentukea	American Yellowwood	B & B	3-3.5" CAL.	
CV-F	1	Chionanthus virginicus	Fringetree	B & B	10-12' HT.	
SHRUBS	QTY	BOTANICAL NAME	COMMON NAME	CONT	SIZE	
AA-L	4	Aronia arbutifolia 'Lowscape'	Lowscape Red Chokeberry	Cont.	15-18" SPD.	
AG-K	5	Abelia x grandiflora 'Kaleidoscope'	Kaleidoscope Abelia	Cont.	15-18" SPD.	
AV-LD	5	Azalea viscosum 'Lemon Drop'	Lemon Drop Azalea	Cont.	3-4' HT	
CA-H	6	Clethra alnifolia 'Hummingbird'	Hummingbird Summersweet	Cont.	2' HT.	
CC-SB	1	Cotinus coggygia	Smoke Bush	B & B	4-5' HT.	
CS-V	3	Cornus sericea 'Variegata'	Variegated Red Twig Dogwood	B & B	3-4' HT.	
DG-N	12	Deutzia gracilis 'Nikko'	Nikko Deutzia	Cont.	15-18" SPD.	
EF-EG	9	Euonymus fortunei 'Emerald Gaiety'	Emerald Gaiety Wintercreeper	Cont.	15-18" SPD.	
EJ-SK	1	Euonymus japonicus 'Silver King'	Silver King Euonymus	Cont.	2' HT.	
HM-B	19	Hydrangea macrophylla 'Bloomstruck'	Bloomstruck Mophead Hydrangea	Cont.	2.5' HT.	
HM-BJ	3	Hydrangea macrophylla 'Blue Jangles'	Blue Jangles Hydrangea	Cont.	18-24" HT.	
HM-C	9	Hydrangea macrophylla 'Cityline'	Cityline Hydrangea	Cont.	18-24" SPD.	
HM-TD	3	Hydrangea macrophylla 'Tokyo Delight'	Tokyo Delight Hydrangea	Cont.	2' HT.	
HP-B	6	Hydrangea paniculata 'Bobo'	Bobo Panicle Hydrangea	Cont.	2' HT.	
HP-L	6	Hydrangea paniculata 'Limelight'	Limelight Panicle Hydrangea	B & B	3-4' HT.	
HP-L2	1	Hydrangea paniculata 'Limelight'	Limelight Panicle Hydrangea	B & B	4-5' HT.	
HP-LL	6	Hydrangea paniculata 'Little Lime'	Little Lime Panicle Hydrangea	Cont.	2' HT.	
HS	3	Hibiscus syriacus	Rose of Sharon	B & B	4-5' HT.	
IC-H	29	Ilex crenata 'Helleri'	Heller Japanese Holly	Cont.	15-18" SPD.	
IC-S	2	Ilex crenata 'Steeds'	Steeds Japanese Holly	B & B	4' HT.	
IC-U	1	Ilex crenata	Upright Holly	B & B	5-6' HT.	
IG-GB	4	Ilex glabra 'Gem Box'	Gem Box Inkberry Holly	Cont.	2' HT.	
IM-BP	6	Ilex x meserveae 'Blue Princess'	Blue Princess Holly	Cont.	2' HT.	
JC	10	Juniperus conferta	Shore Juniper	Cont.	15-18" SPD.	
JV-I	5	Juniperus virginiana 'Idyllwild'	Idyllwild Eastern Redcedar	B & B	8-10' HT.	
LF-N	5	Leucothoe fontanesiana 'Nana'	Dwarf Drooping Leucothoe	Cont.	15-18" SPD.	
MD-SC	10	Microbiota decussata	Siberian Carpet Cypress	Cont.	15-18" SPD.	
MP	1	Myrica pensylvanica	Northern Bayberry	B & B	3-4' HT.	
OH-G	8	Osmanthus heterophyllus 'Goshiki'	Goshiki Holly Olive	B & B	2' HT.	
PA-N	3	Picea abies 'Nidiformis'	Bird's Nest Norway Spruce	Cont.	15-18" SPD.	
PF-B	3	Potentilla fruticosa 'Hachliss'	Bella Bellissima Bush Cinquefoil	Cont.	18-24" HT.	
PJ-DW	3	Pieris japonica 'Dorothy Wycoff'	Dorothy Wycoff Japanese Pieris	Cont.	2' HT.	
PJ-LH	4	Pieris japonica 'Little Heath'	Little Heath Japanese Pieris	Cont.	2' HT.	
PJ-P	1	Pieris japonica 'Prelude'	Prelude Japanese Pieris	Cont.	2.5' HT.	
RH-PG	8	Rhododendron x 'Purple Gem'	Purple Gem Rhododendron	Cont.	15-18" SPD.	
RO-D	10	Rosa 'Drift'	Drift Rose	Cont.	15-18" SPD.	
RS-S	6	Rhododendron x 'Scintillation'	Scintillation Rhododendron	Cont.	2.5' HT.	
RY	1	Rhododendron x 'Yuka'	Yuka Rhododendron	Cont.	18-24" SPD.	
SB-TG	4	Spiraea betulifolia 'Tor Gold'	Glow Girl® Birchleaf Spirea	Cont.	2' HT.	
SD	1	Salix discolor	Pussy Willow	B & B	3-4' HT.	
SH-HS	5	Sarcococca hookeriana	Himalayan Sweetbox	Cont.	15-18" SPD.	
SJ-G	9	Spiraea japonica 'Goldmound'	Goldmound Japanese Spirea	Cont.	2' HT.	
TM-H	12	Taxus x media 'Hicksii'	Hicks Yew	B & B	3-4' HT.	
TO-EG	3	Thuja occidentalis 'Smaragd'	Emerald Green Arborvitae	B & B	6-8' HT.	
TO-EG8	4	Thuja occidentalis 'Smaragd'	Emerald Green Arborvitae	B & B	8-10" HT.	
VC-LD	6	Viburnum cassinoides 'Lil Ditty'	Lil' Ditty Viburnum	Cont.	15-18" SPD.	
VN	1	Viburnum nudum	Possumhaw Viburnum	B & B	3-4' HT.	
VP-SSV	3	Viburnum plicatum 'Summer Snowflake'	Summer Snowflake Viburnum	B & B	4-5' HT.	
SHRUB AREAS	QTY	BOTANICAL NAME	COMMON NAME	CONT		
FS	194	Fern Sod	Fern Sod	1 gal		20" o.c.

Date: 1/30/23

Revisions:
Num. Date Description

Wequasset Resort & Golf Club
Signature Suite
2178 MA-28 Harwich, Massachusetts 02645

Drawn By: DH Checked By: DH

Cottage A, B & K
Plant Schedule

Scale: N/A

Sheet: **L1.4**

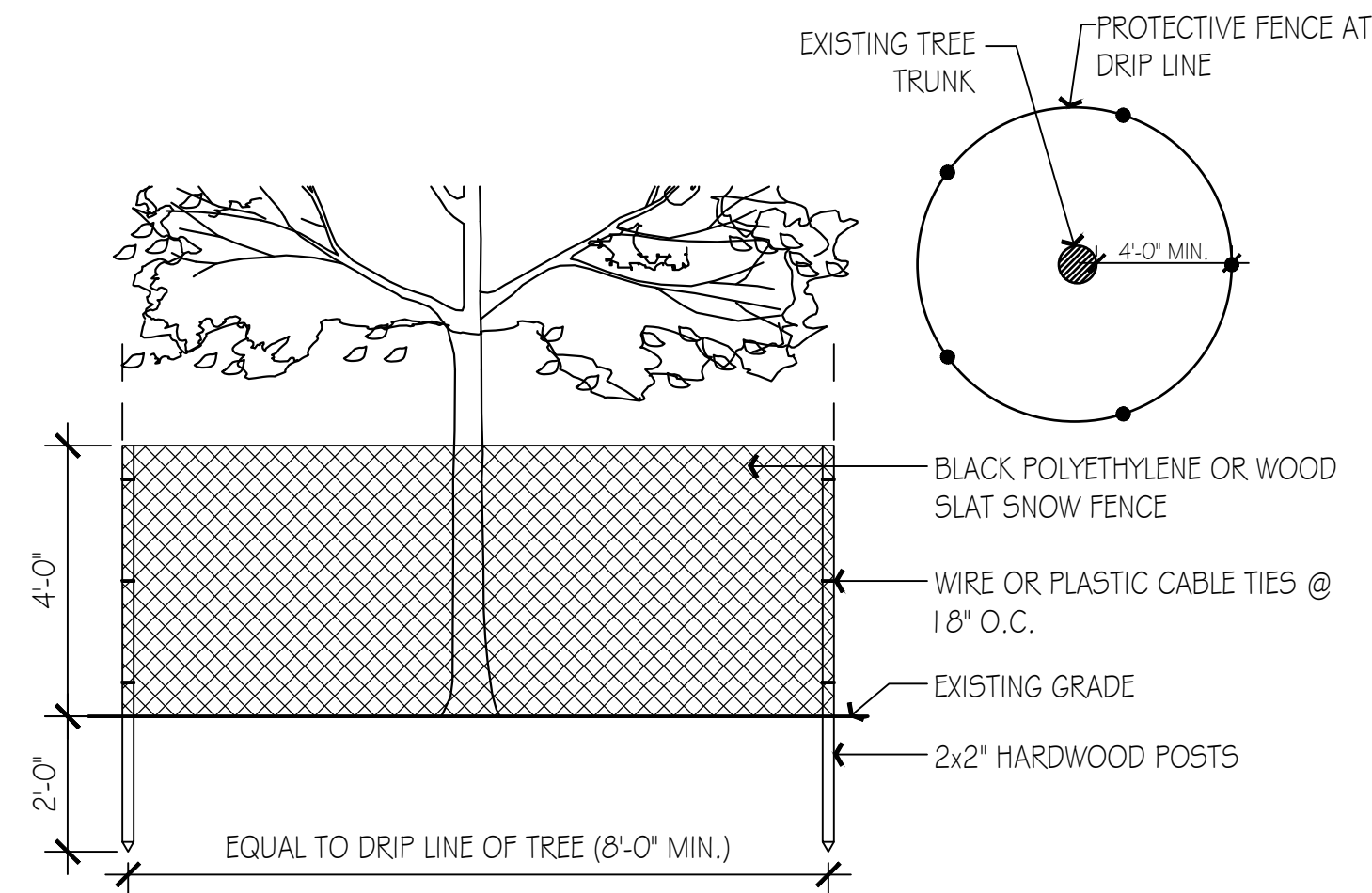

NOTES:

1. PROTECTIVE FENCE TO REMAIN UNTIL CONSTRUCTION IS COMPLETE.
2. NO TREE SHALL BE REMOVED UNLESS SPECIFICALLY TAGGED FOR REMOVAL BY THE LANDSCAPE ARCHITECT.
3. CONTRACTOR SHALL TAKE CARE NOT TO DAMAGE TREES THAT ARE TO REMAIN.
4. DO NOT NAIL BOARDS OR FENCING TO TREES DURING CONSTRUCTION.
5. ANY EXCAVATING WITHIN DRIPLINE MUST BE APPROVED BY LANDSCAPE ARCHITECT AND MUST BE HAND-DUG. CONTRACTOR SHALL NOT CUT ANY ROOTS AND/OR BRANCHES UNLESS APPROVED BY LANDSCAPE ARCHITECT.
6. ROOTS EXPOSED AND/OR DAMAGED DURING GRADING & CONSTRUCTION OPERATIONS SHALL BE CUT OFF CLEANLY INSIDE THE EXPOSED OR DAMAGED AREA AND TOPSOIL BE PLACED OVER THE ROOTS IMMEDIATELY. FEEDER ROOTS SHALL NOT BE CUT IN AN AREA INSIDE DRIP LINE OF THE TREE BRANCHES.
7. ROOTS GREATER THAN 1" DIAMETER SHALL NOT BE CUT UNLESS OTHERWISE APPROVED BY THE LANDSCAPE ARCHITECT.
8. STOCKPILED MATERIALS OR UNNECESSARY VEHICULAR TRAFFIC SHALL NOT BE ALLOWED OVER ANY TREE ROOT SYSTEM.
9. INSPECT FENCE ON WEEKLY BASIS AND REPAIR DAMAGE IMMEDIATELY.

1 Tree Protection

Scale: N/A

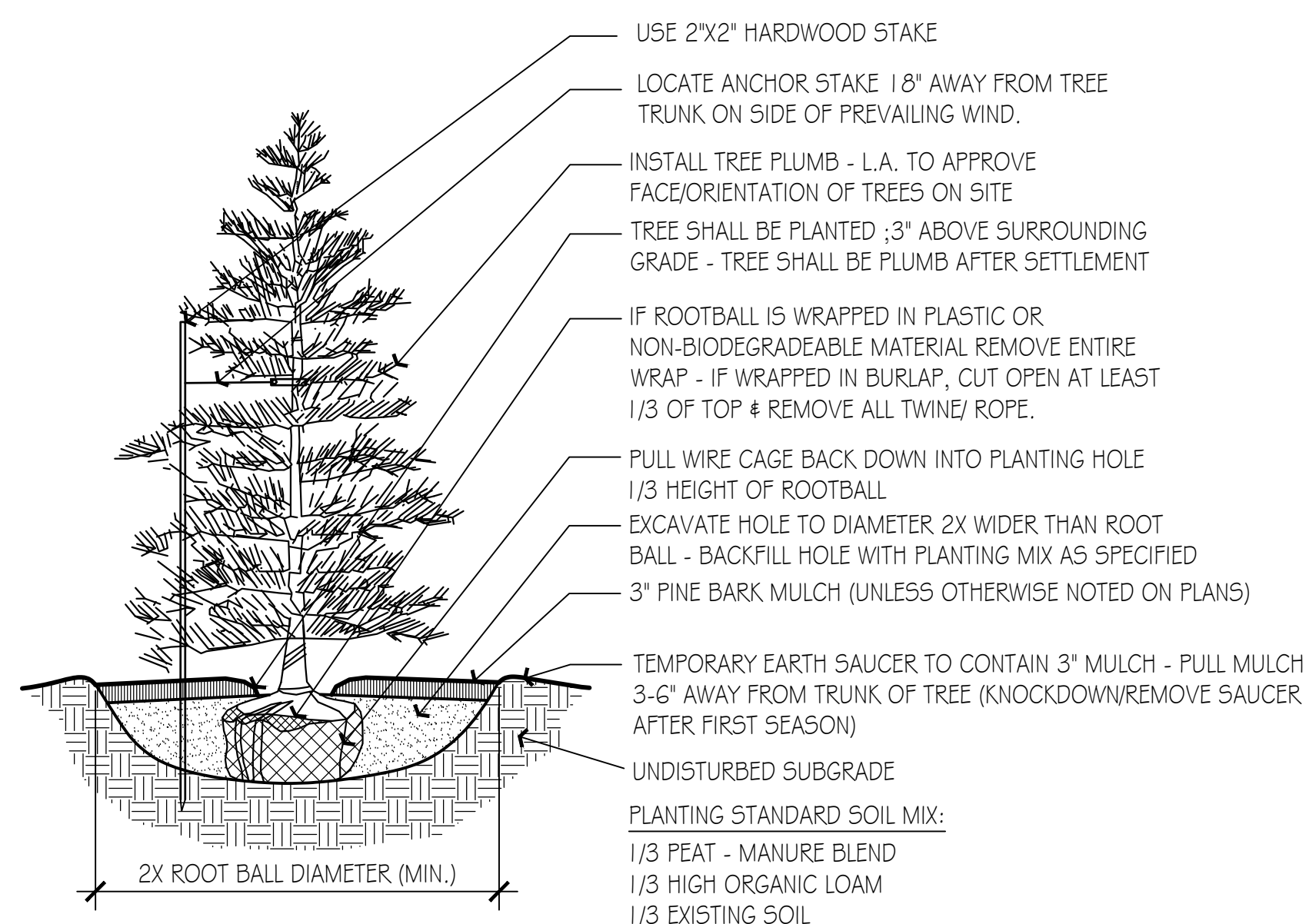

3 Conifer Tree Planting

Scale: N/A

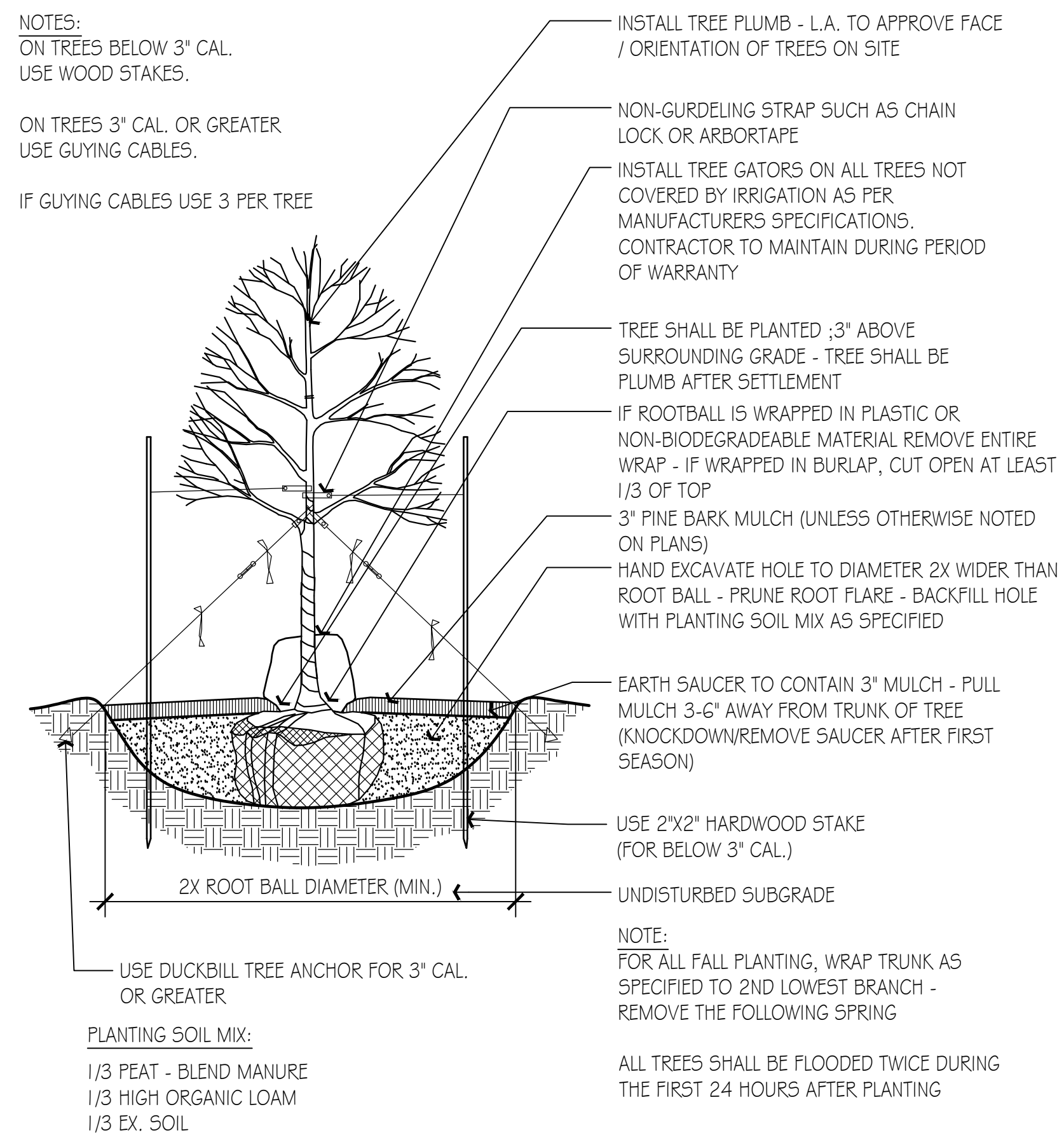

2 Deciduous Tree Planting

Scale: N/A

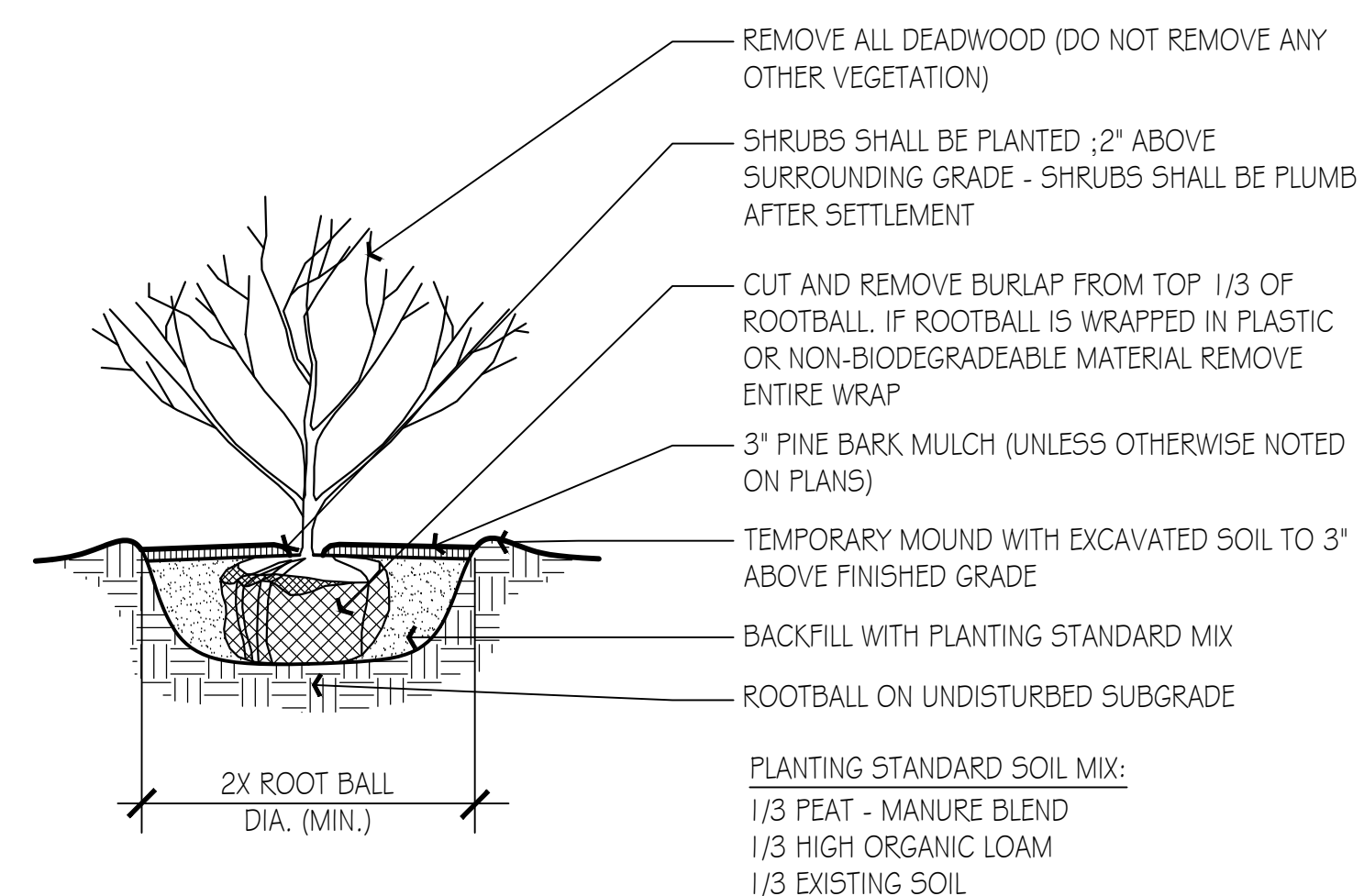

4 Shrub Planting

Scale: N/A

Landscape Notes:

1. ALL WORK TO BE PERFORMED IN STRICT ACCORDANCE WITH THE DEP ORDER OF CONDITIONS, IN ADDITION TO ALL LOCAL ORDINANCES INCLUDING ANY SPECIAL CONDITION REQUESTS BY THE GOVERNING CONSERVATION COMMISSION.
2. ALL DISTURBED AREAS TO BE LOAMED AND SEEDED WITH DROUGHT TOLERANT HIGH FESCUE LAWN AS SPECIFIED ON PLAN.
3. NO HERBICIDES, FERTILIZER OR PESTICIDES SHALL BE USED WITHIN THE WETLAND BUFFERS OF SUBJECT PROPERTY UNLESS APPROVED BY THE GOVERNING CONSERVATION COMMISSION.
4. NO PRUNING OR VEGETATIVE CLEANING WITHIN THE WETLAND SETBACKS UNLESS UNDER THE DIRECTION OF THE CONSERVATION AGENT.
5. THE EXISTING IRRIGATION SYSTEM WILL BE RECONFIGURED TO IRRIGATE THE PROPOSED LAWN AND PLANTING AREAS AS SHOWN ON THE PLAN.
6. REFER TO HARDSCAPE CONSTRUCTION DETAILS FOR INSTALLATION METHODS.
7. A COMPLETE LIST OF PLANTS INCLUDING A SCHEDULE OF QUANTITIES, SIZES AND NAMES IS INCLUDED. IN THE EVENT OF DISCREPANCIES BETWEEN QUANTITIES OF PLANTS IN THE PLANT SCHEDULE AND THE QUANTITIES SHOWN ON THE PLAN, THE PLAN SHALL GOVERN.
8. PRIOR TO ANY WORK BEING PERFORMED, THE LANDSCAPE CONTRACTOR SHALL REQUEST AN ON SITE MEETING WITH THE CONSERVATION AGENT TO REVIEW THE ORDER OF CONDITIONS.

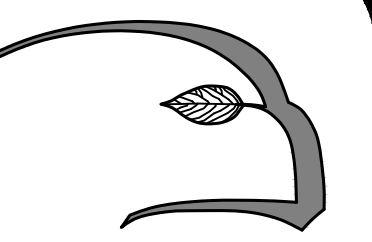

Hawk Design, Inc.
Landscape Architecture
Land Planning
Sagamore, MA
508-833-8800
info@hawkdesigninc.com

HAWK DESIGN, INC. 2023

THIS DRAWING AND ALL INFORMATION CONTAINED HEREIN IS PROPRIETARY INFORMATION OF HAWK DESIGN, INC. AND MAY NOT BE COPIED OR REPRODUCED EITHER IN WHOLE OR IN PART, BY ANY METHOD, WITHOUT WRITTEN PERMISSION OF HAWK DESIGN, INC.

Date: 1/30/23

Revisions:

Num. Date Description

Wequasset Resort & Golf Club
Signature Suite
2178 MA-28 Harwich, Massachusetts 02645

Drawn By: DH Checked By: DH

Planting Details & Landscape Notes

Scale: N/A

Sheet: **L1.5**

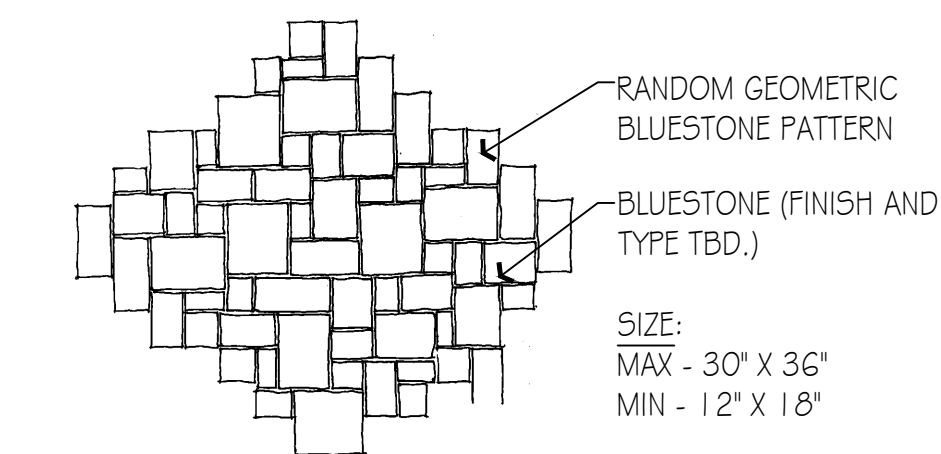
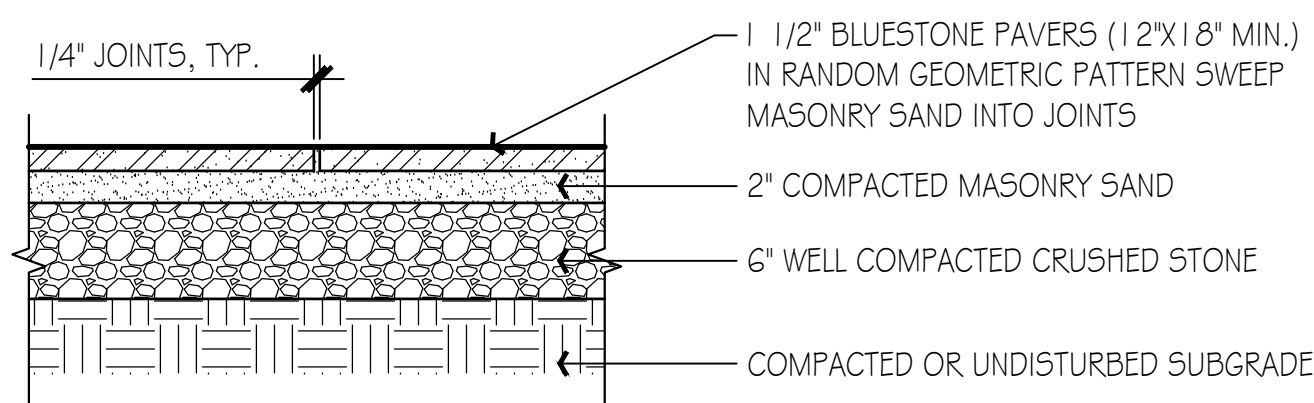

Bluestone Pattern (Not to Scale)

1 Bluestone Paving

Scale: 1" = 1'-0"

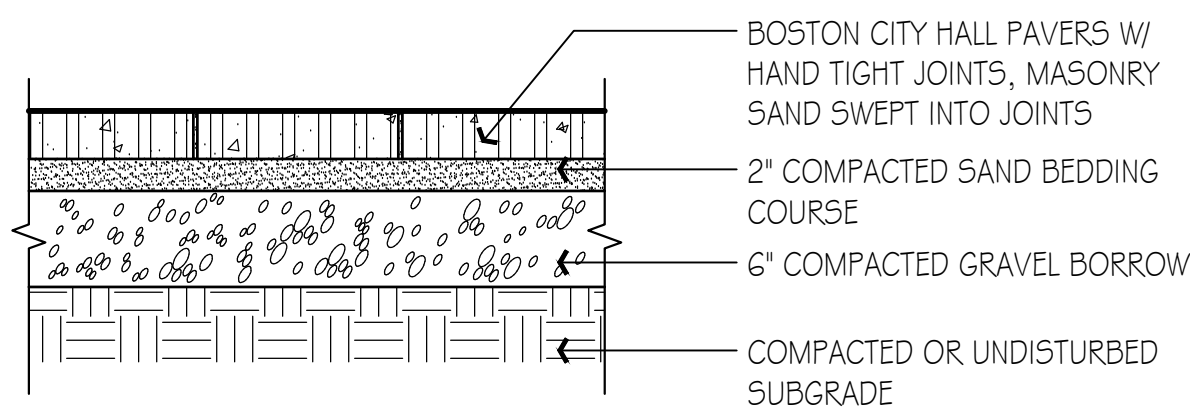

2 Brick Paving

Scale: 1" = 1'-0"

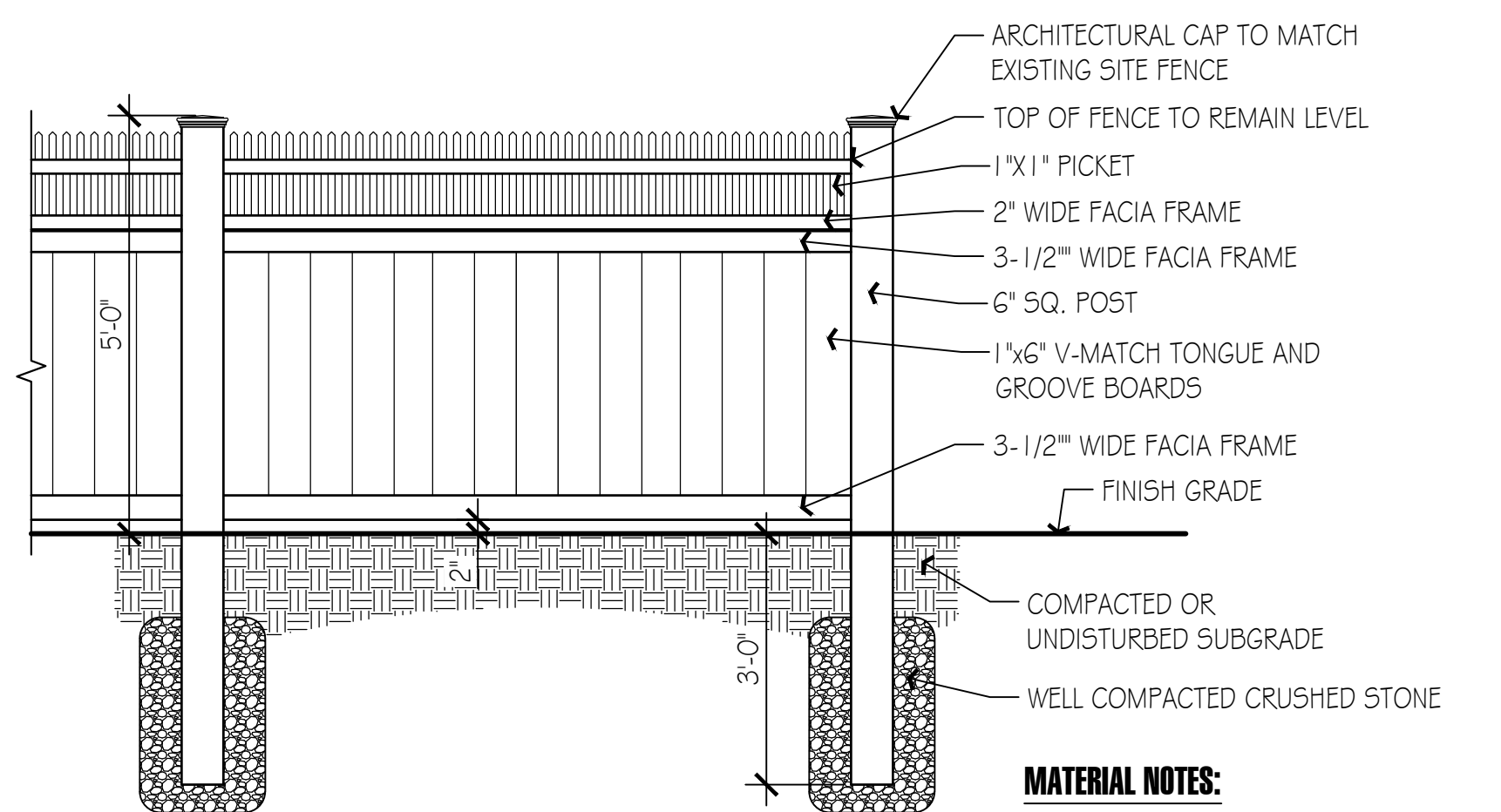

- NOTE:
1. TOP CAP TO HAVE 5% WATER SHED
 2. ALL SCREWS AND FASTENERS TO BE GALVANIZED STEEL
 3. ALL FASTENERS AND PLUGS SHOULD BE ALIGNED TO FORM A PATTERN
 4. CONTRACTOR SHALL VERIFY & INSTALL FENCE IN ACCORDANCE W/ ALL STATE & LOCAL REGULATIONS

3 Privacy Fence

Scale: 1/2" = 1'-0"

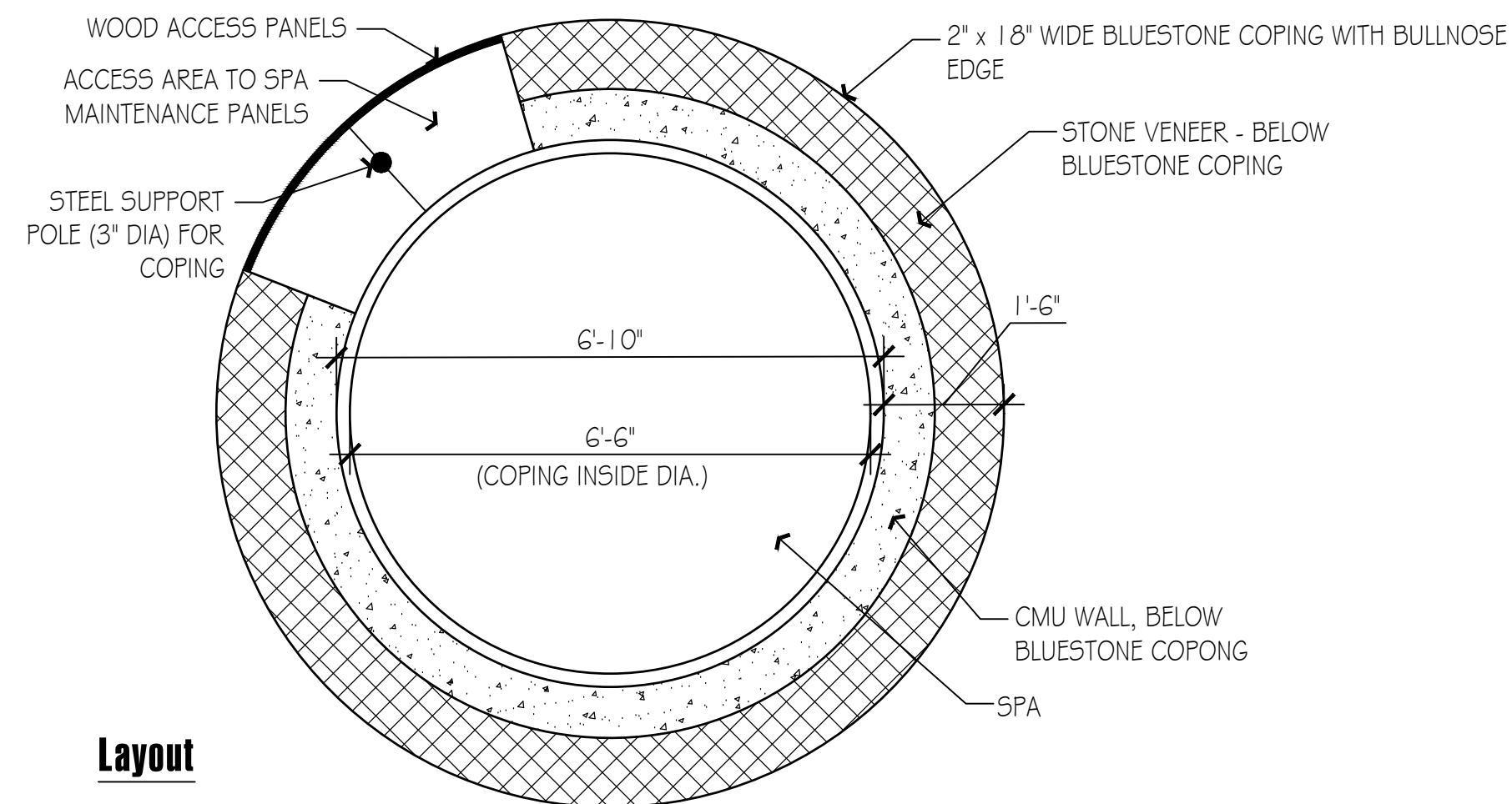

Layout

Notes:

1. CONTRACTOR TO PROVIDE SHOP DRAWINGS FOR WOOD SPA ACCESS DOOR PANELS, TO PROVIDE ACCESS THAT MEETS MANUFACTURER'S SPECS.
2. CONTRACTOR TO PROVIDE WATER AND ELECTRIC AS NEEDED PER MANUFACTURER'S SPECS.

4 Semi-Recessed Spa

Scale: 1/2" = 1'-0"

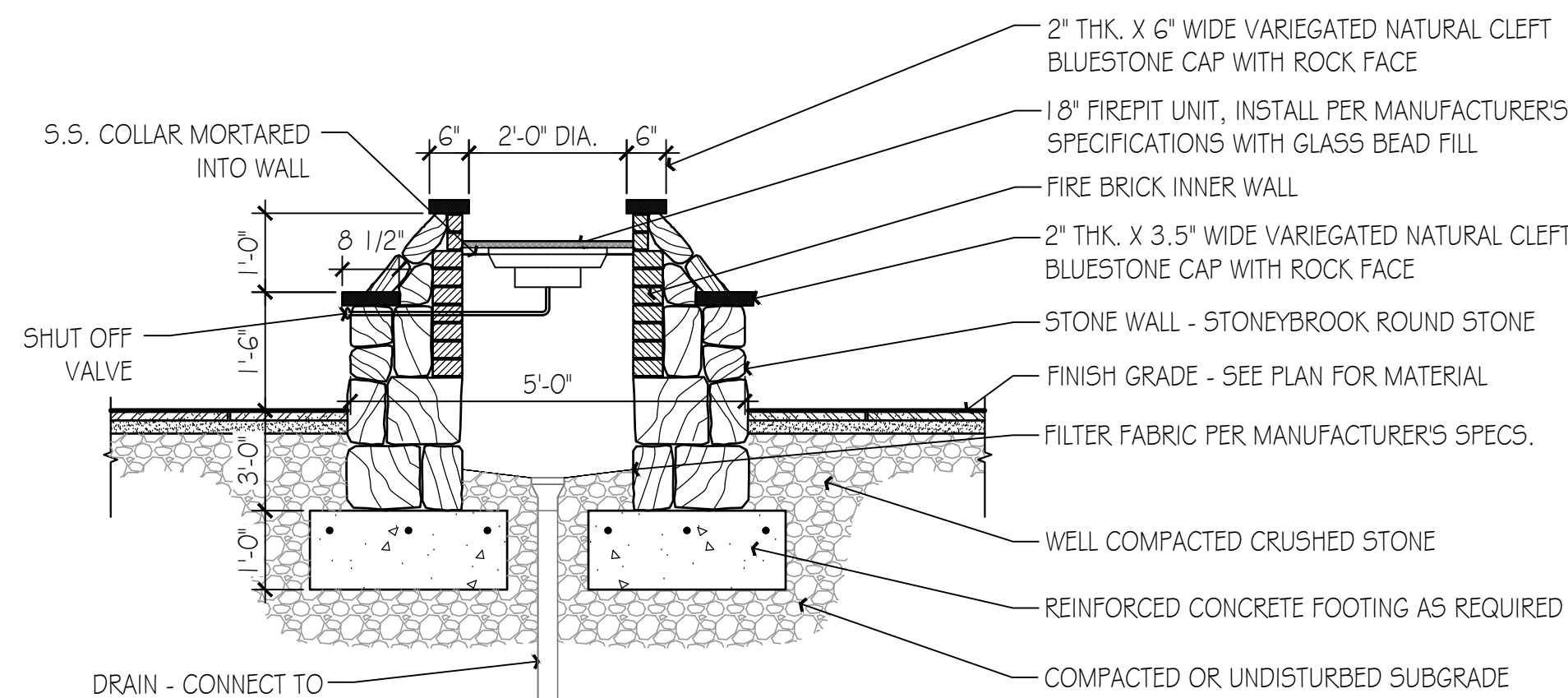

NOTES:

1. PERMITTING - BY OTHERS
2. GAS LINE INSTALLATION - BY OTHERS
3. FIREPIT TO MATCH EXISTING ON SITE.



5 Fire Pit

Scale: 1/2" = 1'-0"

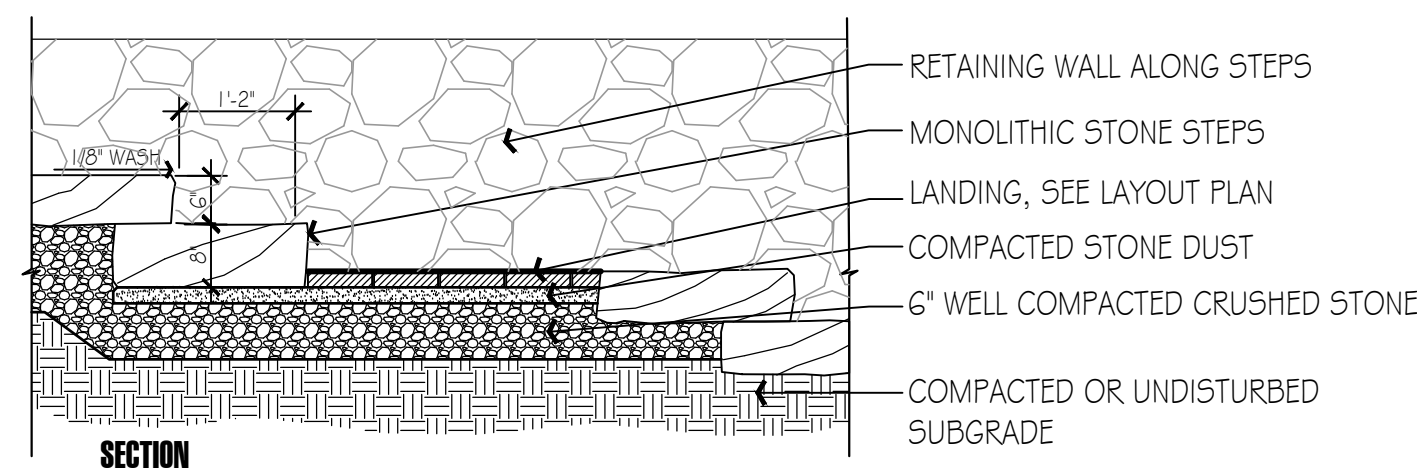

6 Monolithic Steps With Brick Landing

Scale: 1/2" = 1'-0"

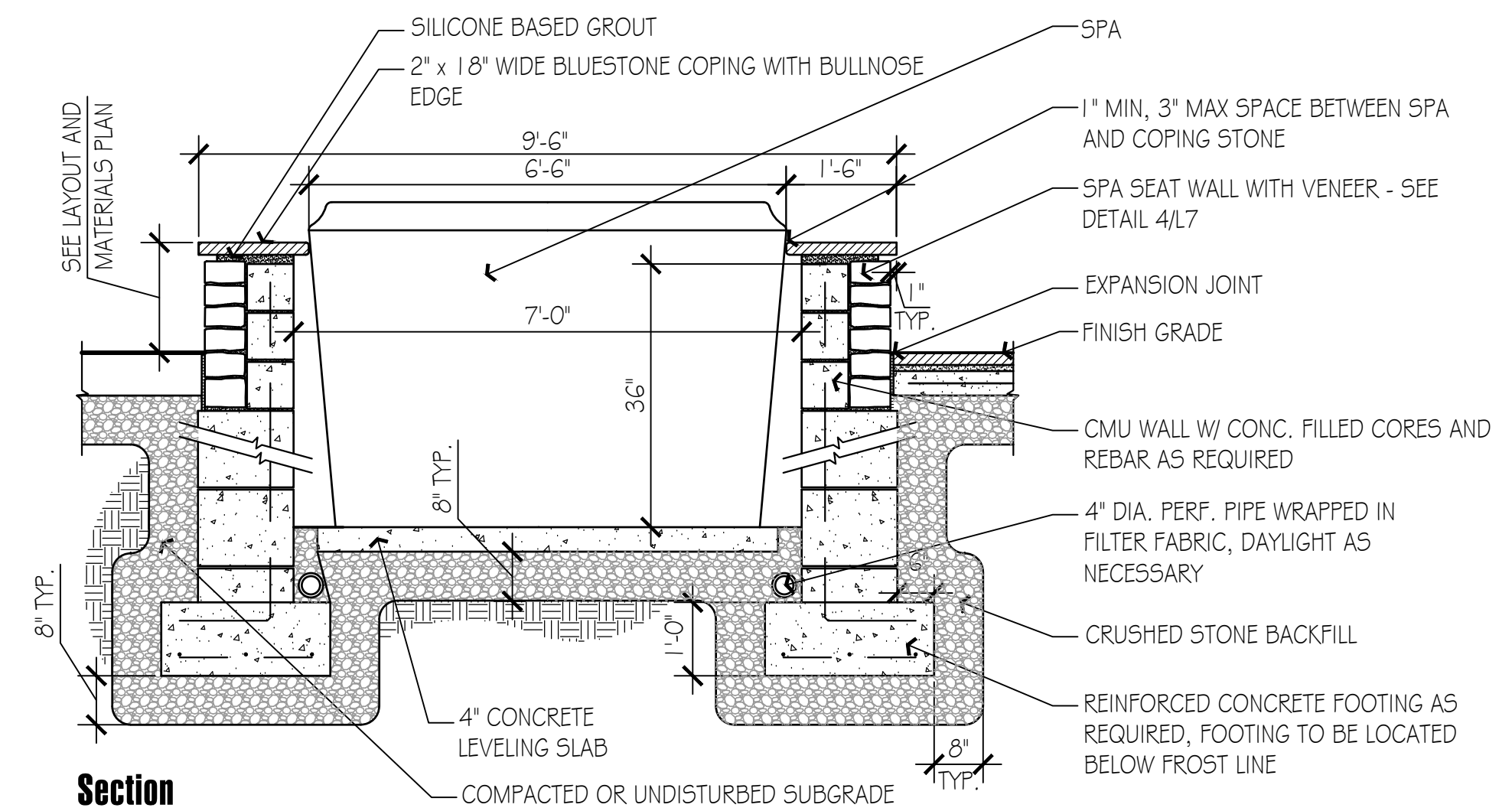

Section

Section

Elevation

NOTES:

1. CONTRACTOR TO PROVIDE CONSTRUCTION DRAWINGS FOR APPROVAL BY LANDSCAPE ARCHITECT AND CLIENT PRIOR TO CONSTRUCTION.

7 Post and Rail Fence

Scale: 1/2" = 1'-0"

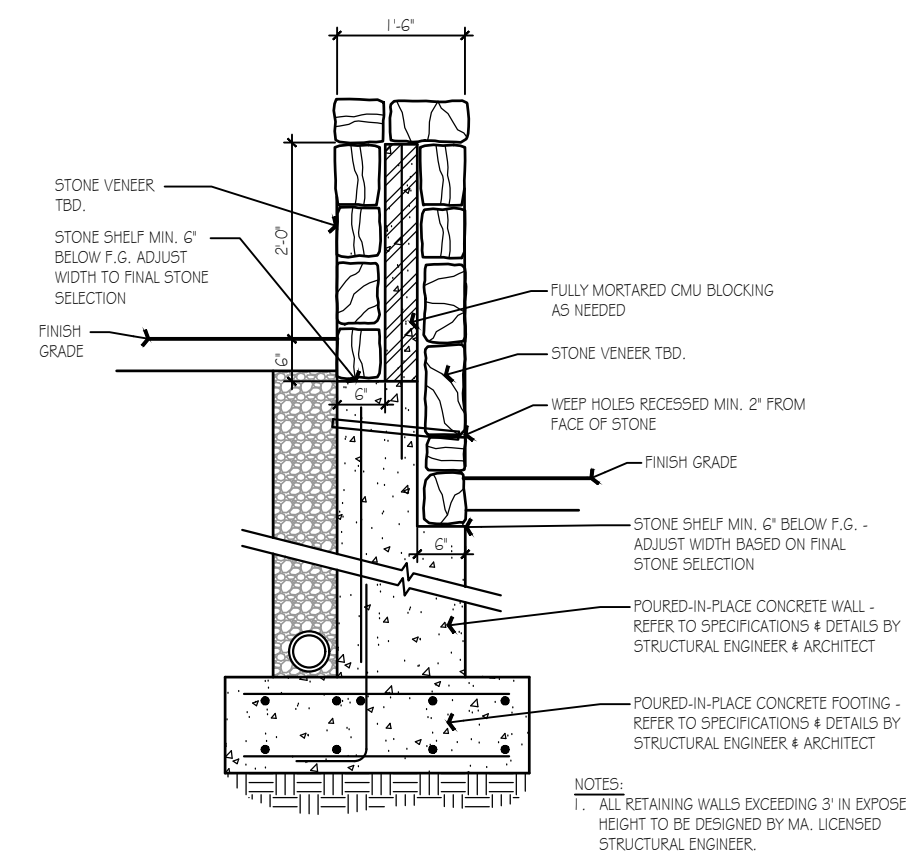

- NOTE:
1. ALL RETAINING WALLS EXCEEDING 3' IN EXPOSED HEIGHT TO BE DESIGNED BY A LICENSED STRUCTURAL ENGINEER.

8 Stone Retaining Wall

Scale: 1/2" = 1'-0"

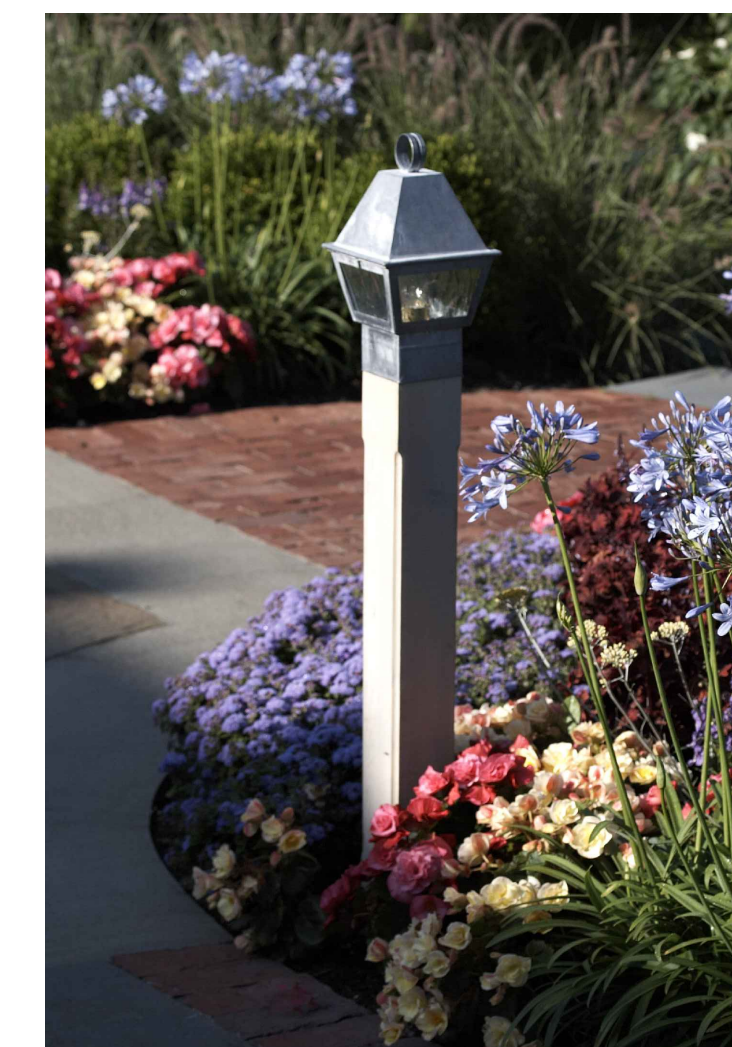

Bollard Light

Hawk Design, Inc.
Landscape Architecture
Land Planning
Sagamore, MA
508-833-8800
info@hawkdesigninc.com

HAWK DESIGN, INC. 2023
THIS DRAWING AND ALL INFORMATION CONTAINED HEREON IS PROPRIETARY INFORMATION OF HAWK DESIGN, INC. AND MAY NOT BE COPIED OR REPRODUCED EITHER IN WHOLE OR IN PART, BY ANY METHOD, WITHOUT WRITTEN PERMISSION OF HAWK DESIGN, INC.

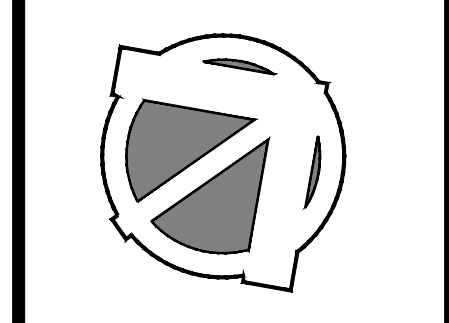

Date: 1/20/22

Revisions:
Num. Date Description

Wequasset Resort & Golf Club
Signature Suite
2178 MA-28 Harwich, Massachusetts 02645

Drawn By: DH Checked By: DH

Construction Details

Scale: As Noted

Sheet: **D1**